

Air curtain: ZEN (M, G, ECG)



INSTALLATION, OPERATION AND MAINTENANCE MANUAL



*Please, read these instructions carefully before attempting installation
Deliver this manual to the final user.*

SECURITY ADVISE SYMBOLS



Attention, Danger, Safety Advice!



Danger from electric current or high voltage!



Injuries risk!



Danger! Do not stay underneath: Heavy load.



Important information.

INDEX

INSTALLATION	4
TRANSPORTATION AND STORAGE	10
OPERATING INSTRUCTIONS.....	10
ELECTRICAL SCHEMES.....	14
DATA SHEET	18
MAINTENANCE INSTRUCTIONS	20
REPAIRS AND REPLACEMENTS	24
FAULTS AND SOLUTIONS	30
DECLARATION OF CONFORMITY.....	32
IDENTIFICATOR	34
GUARANTEE	34

INSTALLATION

Tips and recommendations for a good installation

LENGTH

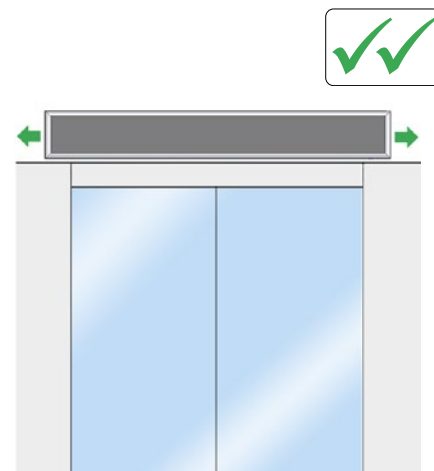
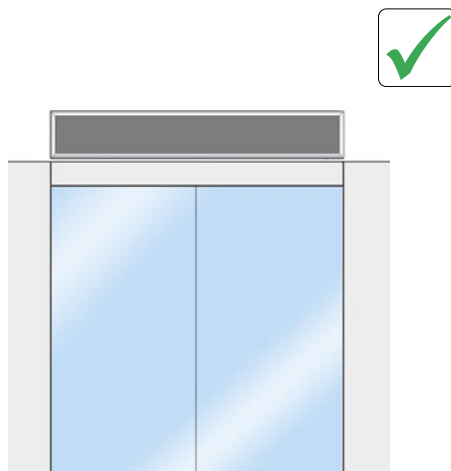
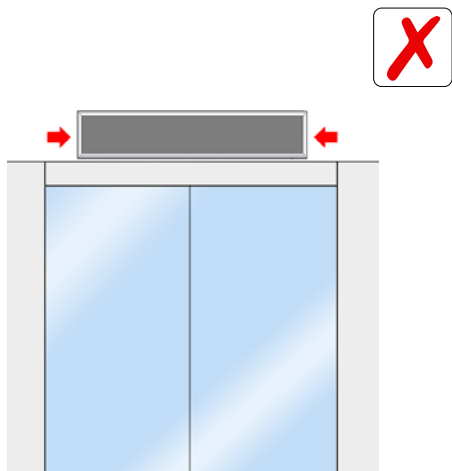

CENTERED / HEIGHT

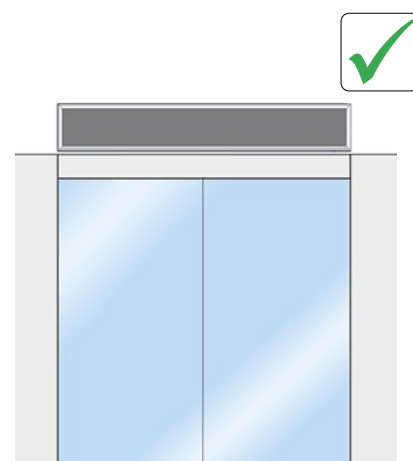
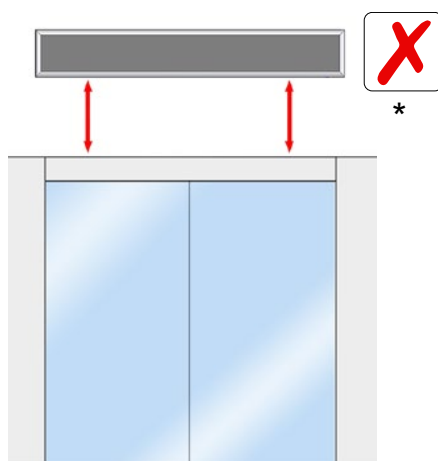
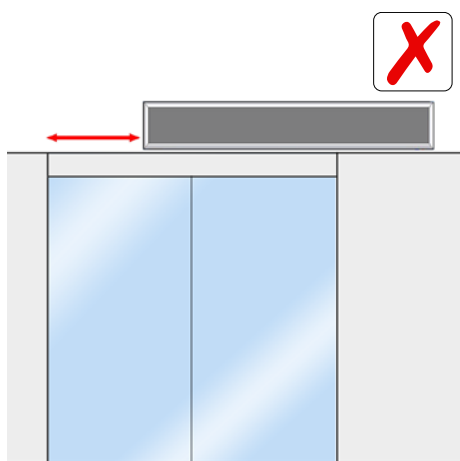

(*) Unless it has been designed to be installed at that height.

DOOR DISTANCE

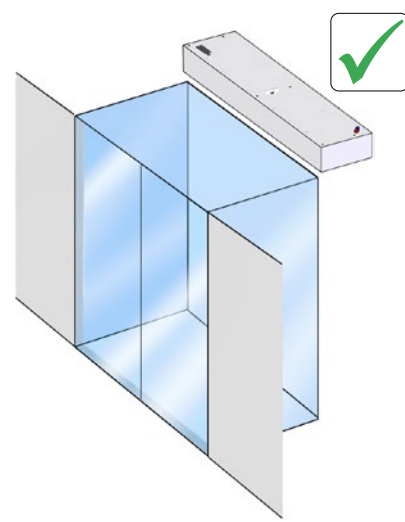
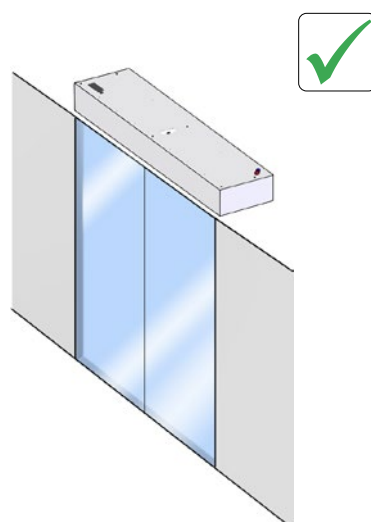
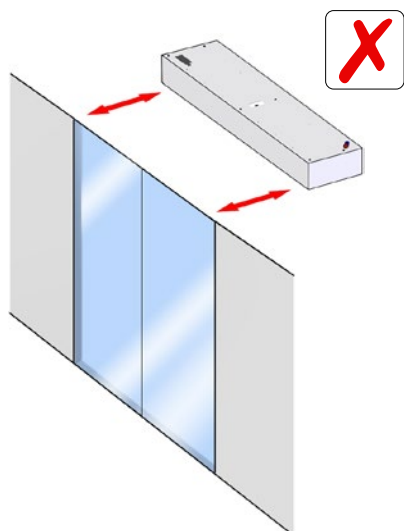

AIR DISCHARGE

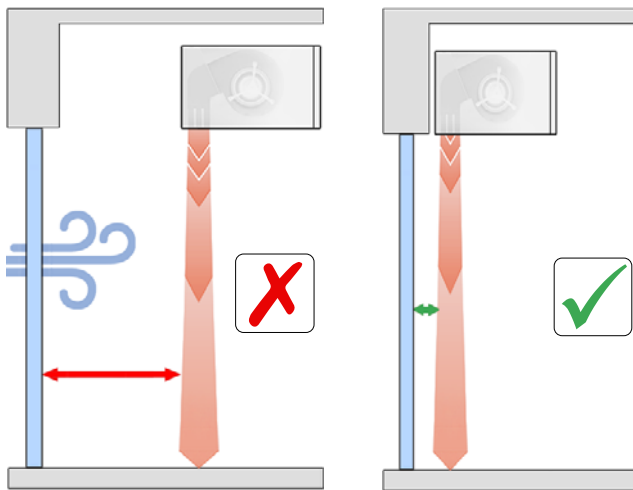

AIR ASPIRATION

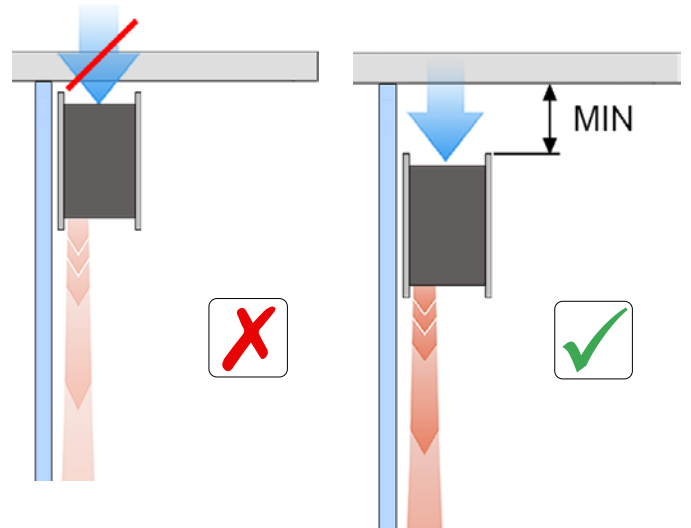

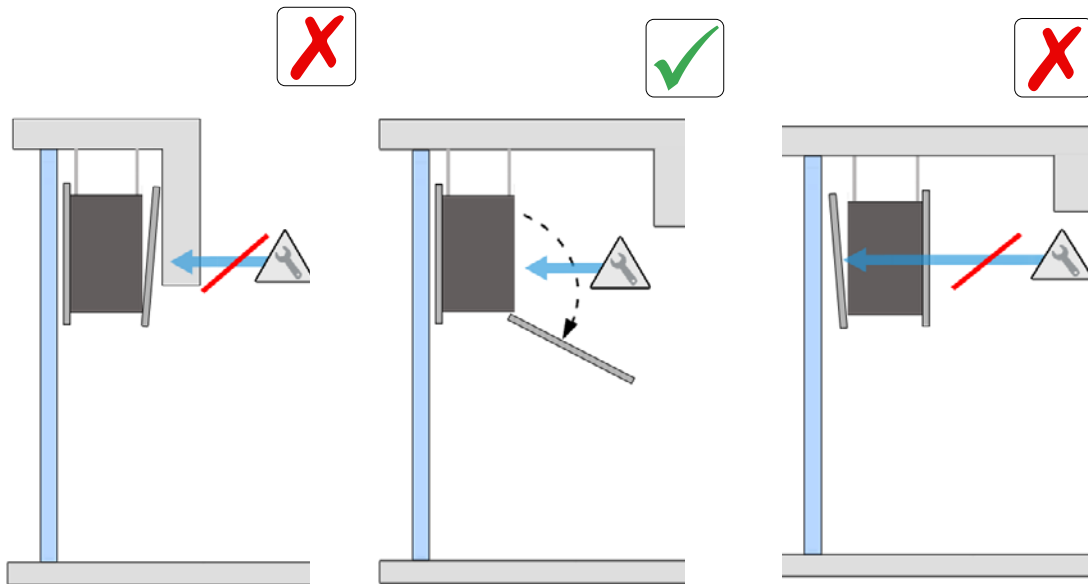

MAINTENANCE ACCESSIBILITY

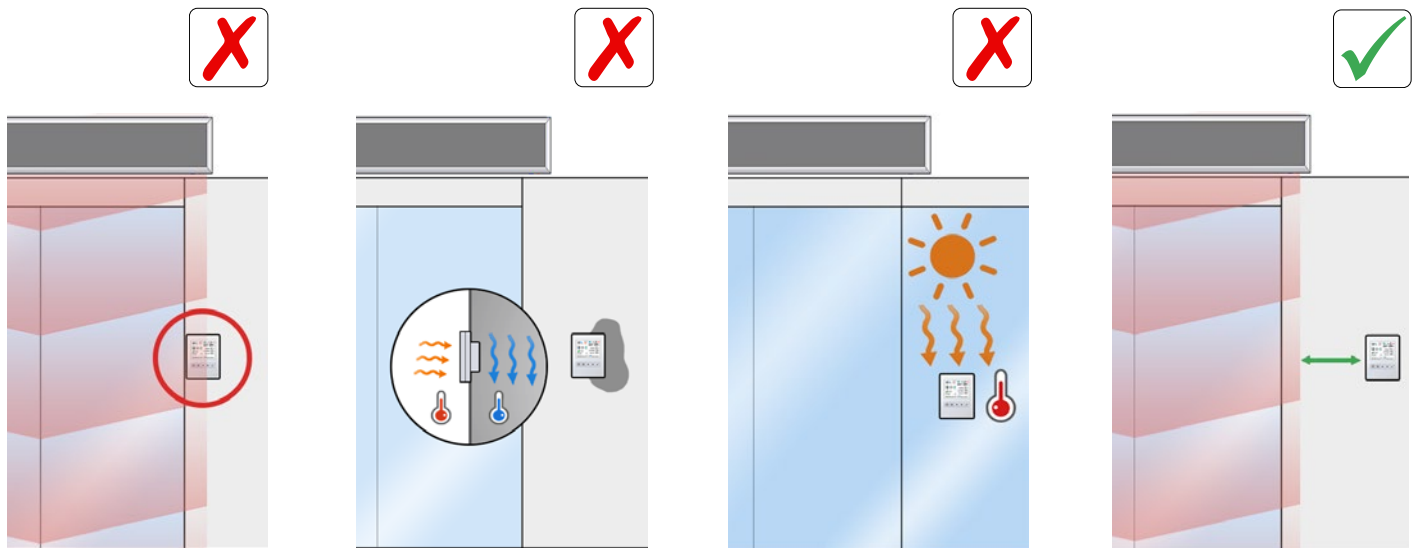

CONTROL (CLEVER)



ZEN model

	<p>Installation work, connection, disconnection, electrical wiring, mechanical maintenance and service must be done by qualified people observing these instructions and in accordance with all applicable norms and standards. If the unit is operated with additional controller, please consider its specific instructions.</p>
	<p>For ZEN model is necessary to open the service door to connect the air curtain. See how to open service door at repairs section.</p>
	<p>For safety, the air curtains never have to be stopped by disconnecting them from the main supply, always through the controller and waiting 10 minutes at least to disconnect the main supply. In case to not follow these instructions, the internal parts of the air curtain can be damaged.</p>

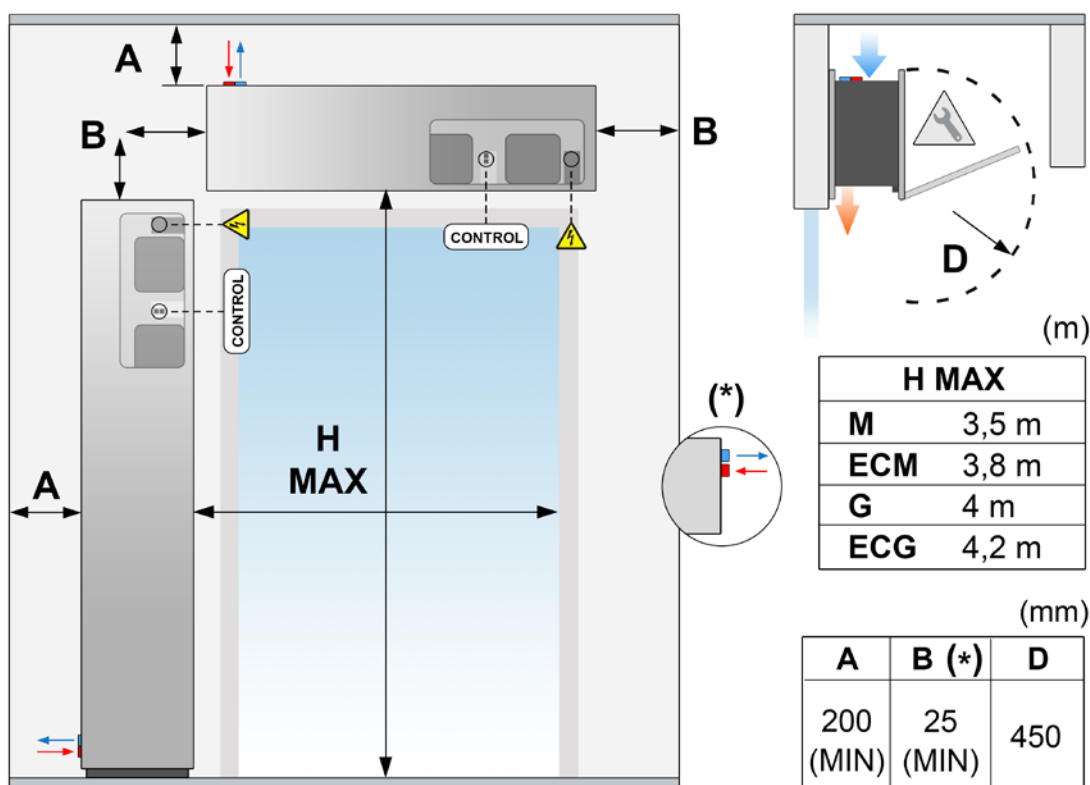

H MAX. Maximum recommended range, MIN. Recommended minimum distance

(*) Standard equipment. Upon request, this distance can be reduced to 25 mm when the connections are located inside the equipment and the tube outlet is lateral. In this case, dimension B will be 100 mm. The minimum recommended distance between the suction grille and any obstacle is 200 mm (Dimension A) Dimension D: service opening distance.

Connexion diagram

Standard without heating, with water and electric heating 400V x 3

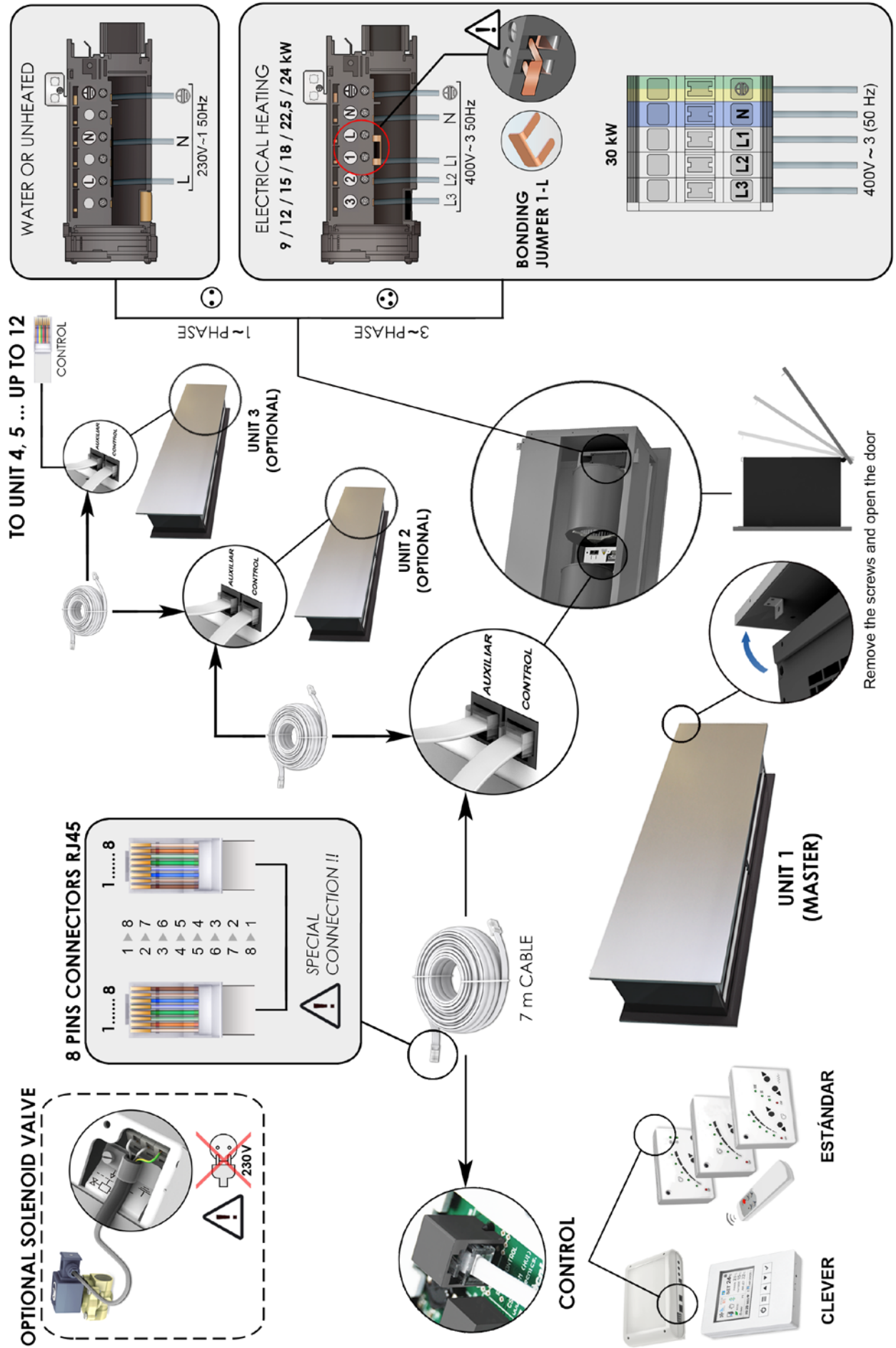

Power supply

To connect the device to power, there is a black junction box at the interior of the air curtain.



For curtains without heating or with water heating, the curtain must only be connected to a 230V single-phase current for the operation of the fans.

In the case of a curtain with an electric battery, connect the 400Vx3 three-phase power supply from the electric battery. Optionally, the battery power can be 230Vx3 three-phase or 230Vx1 single-phase (special diagram included).

The single-phase current is only connected to one phase of the three-phase lines, plus a connection to the neutral. Recommended maximum number of curtains connected to the same differential:

Model	Differential 30mA	Differential 300mA
M-G	20 uds.	20 uds.
ECG	2 uds.	20 uds.

Each installation must be reviewed by a specialist to ensure that there is no incompatibility with the selected differential and the connected curtains.

Regulator and board

To connect the controller to the curtain, there is a connector located in the inside of the air curtain. Use the 7 meter RJ45 cable supplied with the equipment. The communication between the controller and the board is digital and low voltage.



Fixings

The curtain has four external fastening points depending on the weight and length (see situation in the model characteristics section).

Generally, air curtains are installed horizontally. For vertical installation, use the feet kit (see accessories section). The anchor must be sized according to the weights of each curtain indicated on the technical data page. The installation can be done using threaded rods, tensioners or other supports (see available supports in the accessories section).

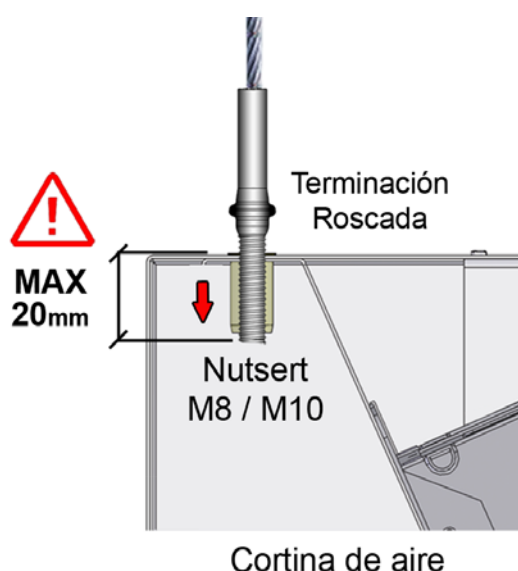

Water coils

The air curtains with water coil have a 230Vx1 output to optionally connect a solenoid valve (it opens or closes the water inlet to the heat exchanger of the coil). This outlet can also be used for other low amperage electrical appliances (10A).

Recomendations:

- Close the hot water circulation (valve) to avoid overheating of the motors while the equipment is off. Optionally, we have solenoid valves.
- In the installation of the building, two shut-off valves (outflow and return) should be provided to be able to disassemble the equipment without problems.
- Mount a purge valve at the highest point of the heating section.

The ambient temperature must always be higher than +4° C. Otherwise, the equipment must be provided with a frost protection device (antifreeze sensor).

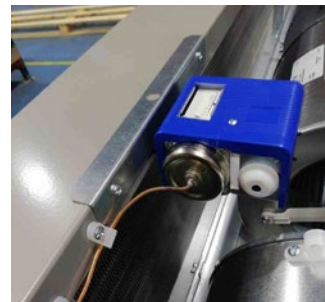

The water batteries have a drain screw in the collector area.

Electrical coils

The electric battery has nine resistances in the form of a bar that, combined with each other, provide 3 stages of heating. Control is carried out by three PRBEOs up to 27kW included.

From there, the control is carried out by two contactors.

All the batteries are electrically and electronically protected against overheating (see section “Operating instructions”).

Electric controllers have the option of including an external thermostat to control heating on and off based on temperature.

During the first uses, the electric battery can give off some odor that disappears in a few days.

According to battery power, the regulation is carried out by:



Coil heating power (kW)	Regulation type
9 / 12 / 15 / 18 / 22,5 / 24	PRBEO
30	CONTACTORS

TRANSPORTATION AND STORAGE



Warning! Heavy load.
Do not stand under the suspended load during transportation or assembly.

Store in a dry place protected from the environment. If the package is opened, cover the curtain to protect it from the dust. Do not step on or place heavy loads on it to avoid damage to the material. Storage temperature between -20 °C and +40 °C.

When transporting the material, you must ensure that it is not damaged by the forklift. (possible penetration of the fork in the packaging). Observe the instructions on the packaging for correct manipulation of the product.



OPERATING INSTRUCTIONS



For safety, the air curtains must never be stopped by disconnecting the current, always do it through the controller. If the power is turned off to turn off the shade, or within ten minutes of turning it off with the controller, internal components may be damaged.

Characteristics of regulation boards

Depending on the type of fan, the air speed is regulated by:

- AC (MG): 110 - 230 V voltage range.
- EC (ECG): from 0 - 10V DC voltage range.

Common characteristics to all regulators

There are various regulator models depending on the customer's needs: timers, antifreeze detectors, thermostats, etc.

- 5 fan speeds.
- Memory: guarantees that, in the event of a power outage, the selected speed is maintained when service is restored. This function can be activated/deactivated using the ON/OFF switch located inside the regulator.



- **RJ45 cable and digital communication:** they have a fast connection with a telephone type cable and digital communication between the regulator and the curtain. This type of communication is reliable even over long distances (up to 20 meters).

- **External start-stop:** inside the regulator there is the possibility of connecting a normally open contact (1,2) that governs the on/off of the equipment through any external device. The contact is potential free. When the contact is closed, the curtain has a 30-second delay before stopping. It can be used for a timer, temperature sensor, fire alarm, PLC, etc.



- **Remote control:** all standard dimmers have an IR receiver that allows them to use a remote control.

Common characteristics of the regulators for curtains with water coil



Regulator for curtains with water coil

- **Heating ON/OFF:** With the “HEAT” ON/OFF button, the 230Vx1 power supply to the solenoid valve is manually activated or deactivated so that it opens or closes the passage of water to the coil. This 230x1 output is located in the upper part of the unit, next to the regulator’s RJ45 cable connection.
- **External thermostat (regulator solenoid valve):** If you want to control the water inlet to the coil by means of a thermostat, the thermostat must be installed in series with the solenoid valve. In this way, when the set temperature is reached, the solenoid valve closes the passage of water.
- **Security thermostat:** If the interior temperature reaches 60 °C and the maximum speed of the curtain is not selected, the ventilation speed automatically increases by 1 speed every 2 minutes to evacuate the excess of thermal energy inside. It will continue at full speed until the inside temperature drops below 50°C.

Safety operation is indicated by a flashing LED. If security is activated on a regular basis, you need to find out the cause. It is most likely that the frequency of cleaning the suction grille will have to be increased. For example, an obstruction in the suction grille, the motor stopped, a high room temperature in an installation without a room thermostat, etc., would cause the curtain to speed up automatically. It also prevents the air expelled by the curtain from exceeding 60°C (excessive thermal sensation for people).

Common characteristics to all regulators for electric batteries

System with 5 fan speeds and 3 heating stages (C1, C2, C3 = [C1+C2]).

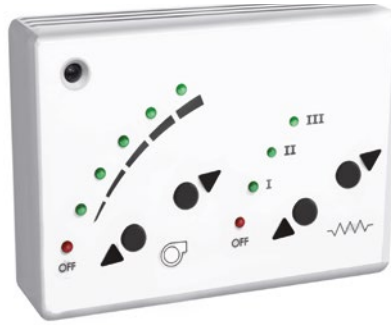

3 heating powers: C1=1/3 Total, C2=2/3 Total, C3=C1+C2=Total.

Limited heating: for reasons of equipment safety, the heating power is limited by the ventilation speed that we have selected, as follows:

Selected speed	Heating máx power
V1	1st stage heating
V2	2nd stage heating
V3	2nd stage heating
V4	3rd heating stage (1st stage + 2nd stage)
V5	3rd heating stage (1st stage + 2nd stage)

Delay thermostat: When the equipment is stopped with the heating on, there is an increase in temperature inside it that could damage it due to the thermal inertia of the electrical resistors. To avoid this, the curtain continues to work up to 90 seconds after stopping; and if when stopping the curtain, the temperature rises above 50 °C, the equipment goes to maximum speed and does not stop until the excess thermal energy is evacuated.

Security thermostat when the curtain works with heating and the internal temperature rises above 60 °C, the safety function is activated: it increases 1 air speed every two minutes until reaching the maximum speed. Then, it starts down 1 stage of heating until it stops. If it persists, after two minutes, it blocks the heating. To unlock it you have to remove the current from the curtain. If at any time the internal temperature does not reach the limit of 60 °C and a downward trend begins, this process is interrupted and returns to normal. A delay in cleaning the suction grille or a high ambient temperature could temporarily activate this function.

Ambient thermostat: the curtain is equipped with the necessary contacts to be able to install, if desired, a room thermostat that stops the heating when the set temperature is reached. It is recommended when the equipment is installed in a closed area of reduced dimensions. If you install the room thermostat, remove the jumper between terminals 4 and 5 of the controller and connect the thermostat there.

The air speed and heating stage are indicated by a continuously lit LED, while the safety speed is indicated by a flashing LED. The heating lockout is indicated by its OFF LED flashing at a faster rate.

Special regulators

If there is a need to be able to control more parameters (intelligent proactive regulation, automatic/manual operation, door delay, time programmer, energy saving mode, multi-device management and BMS Modbus connection, among others) , there are two controllers that allow much more possibilities than the standard controller, especially the Clever. The following regulators have their own manual:

- Hand Auto
- Clever control

Remote Control Features

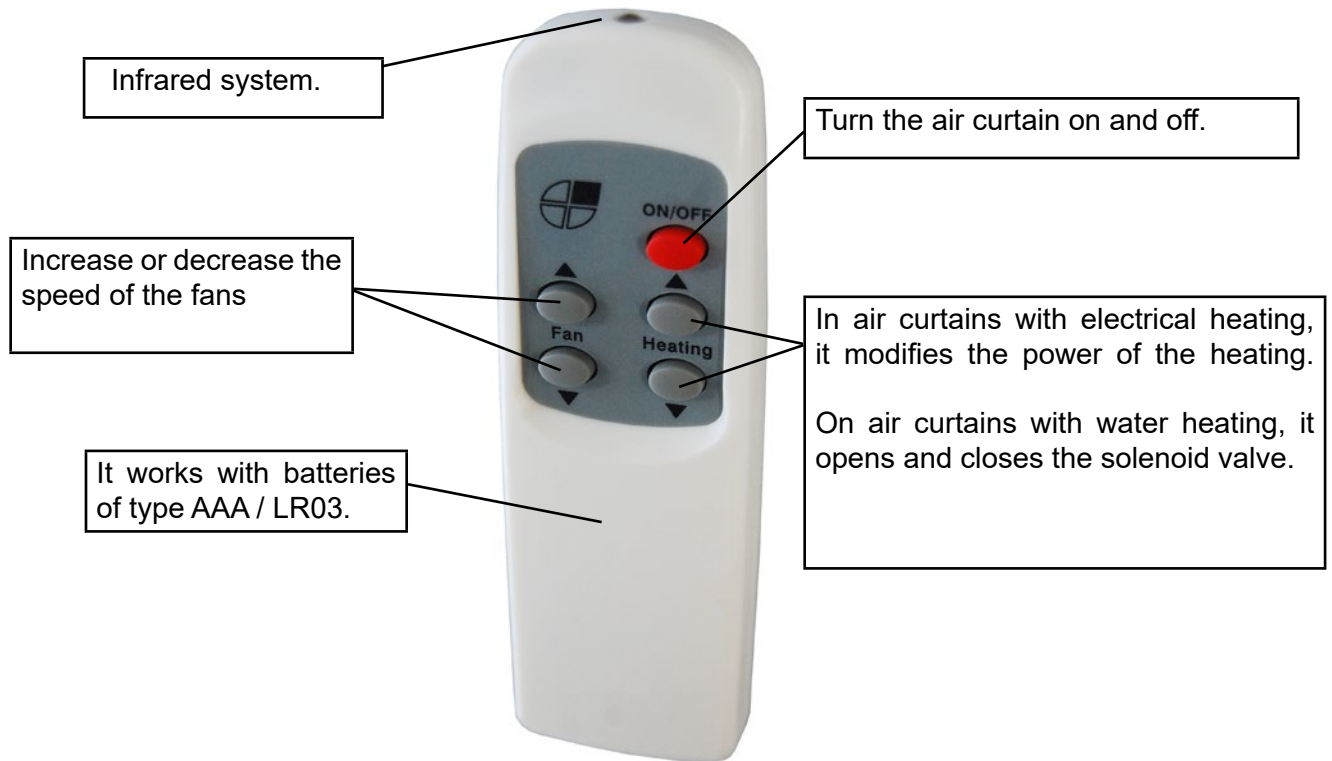

ELECTRICAL SCHEMES

Curtain with water battery or only air with standard regulator (AIRDOE09051)

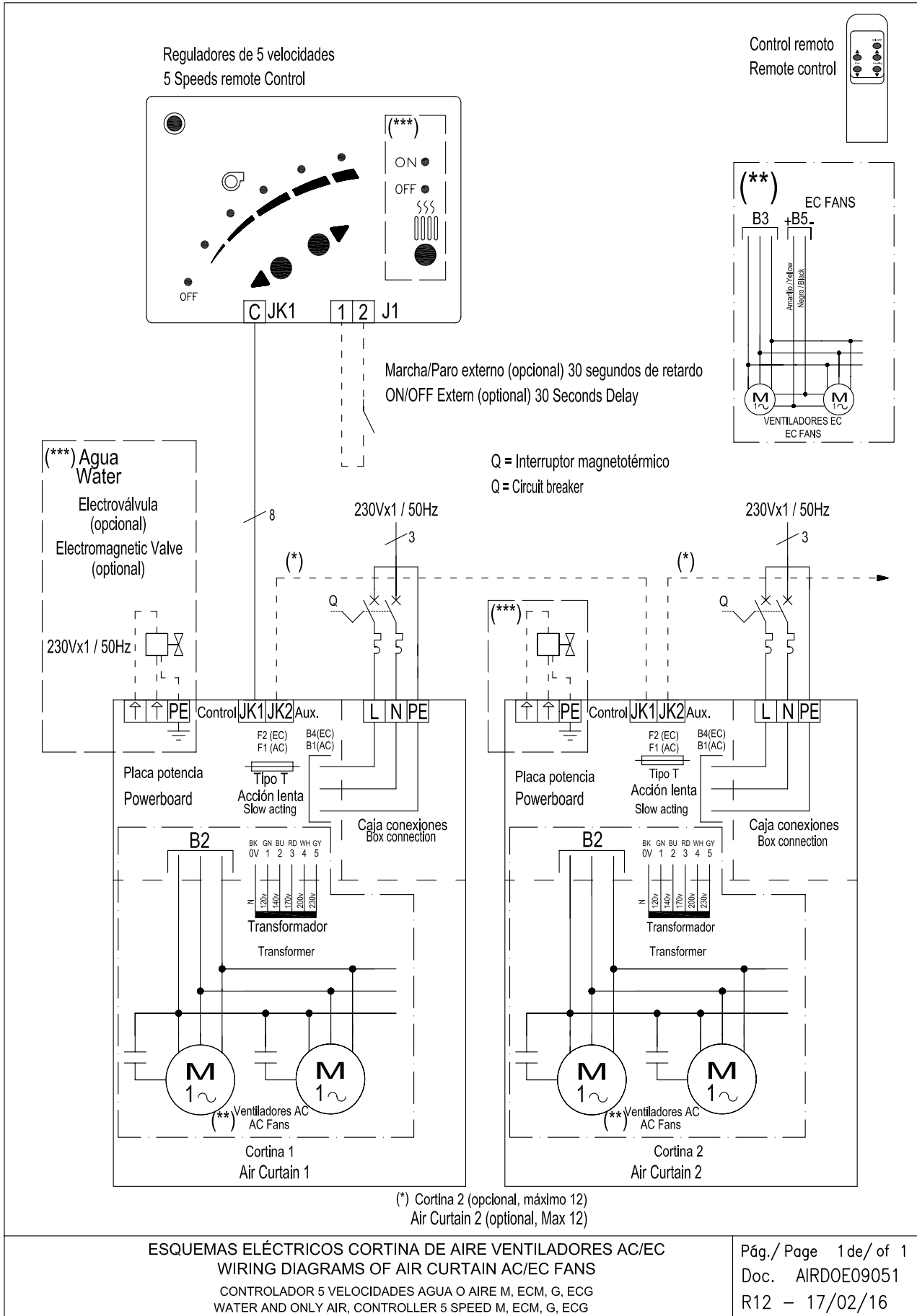

In case there is a need to connect the curtain to a PLC, the corresponding diagram is attached.

Curtain with water battery or without heating with Hand Auto (AIRDOE09251)

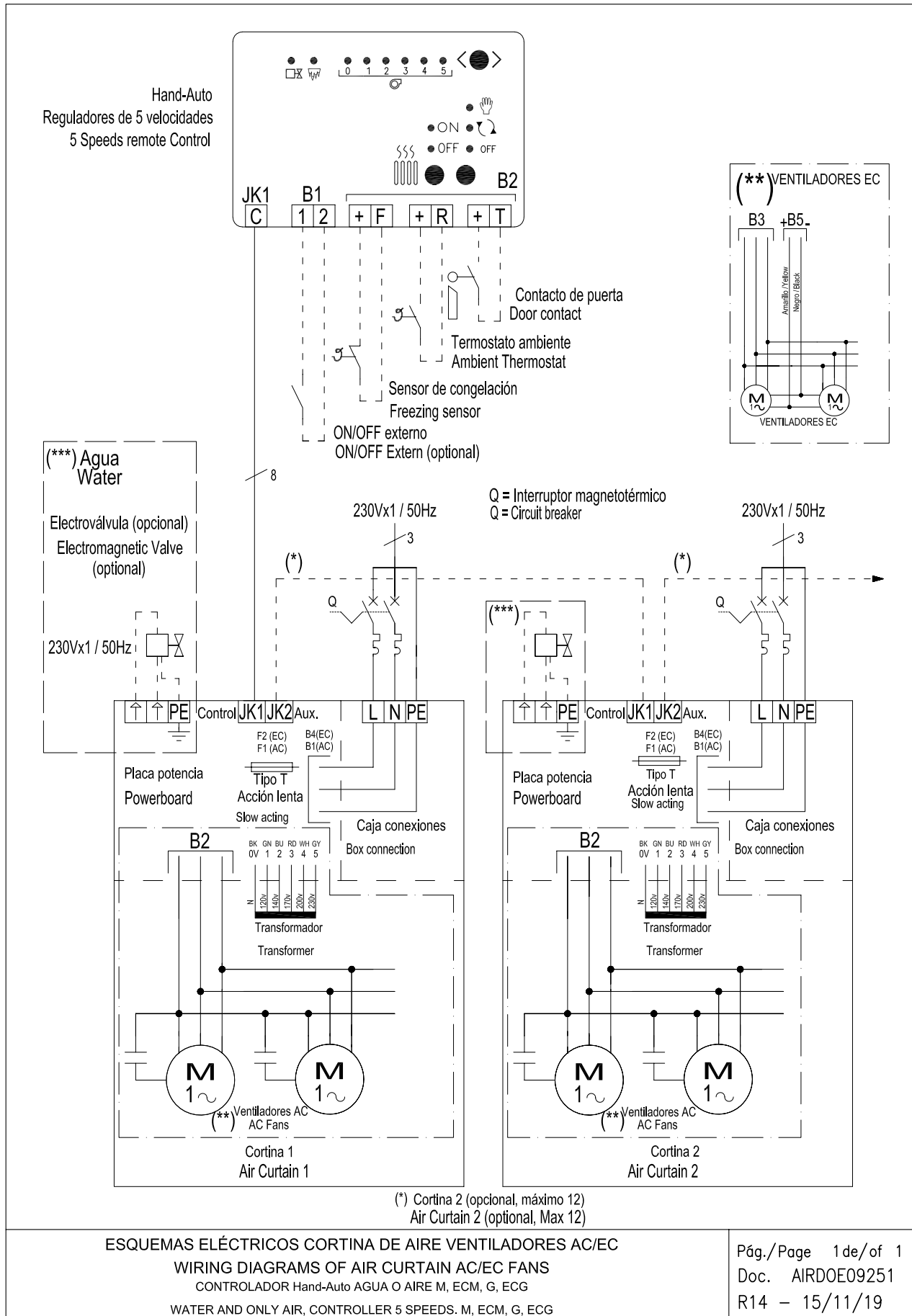

In case there is a need to connect the curtain to a PLC, the corresponding diagram is attached.

Electric curtain <27kW with PRBEO and standard regulator (AIRDOE09110)

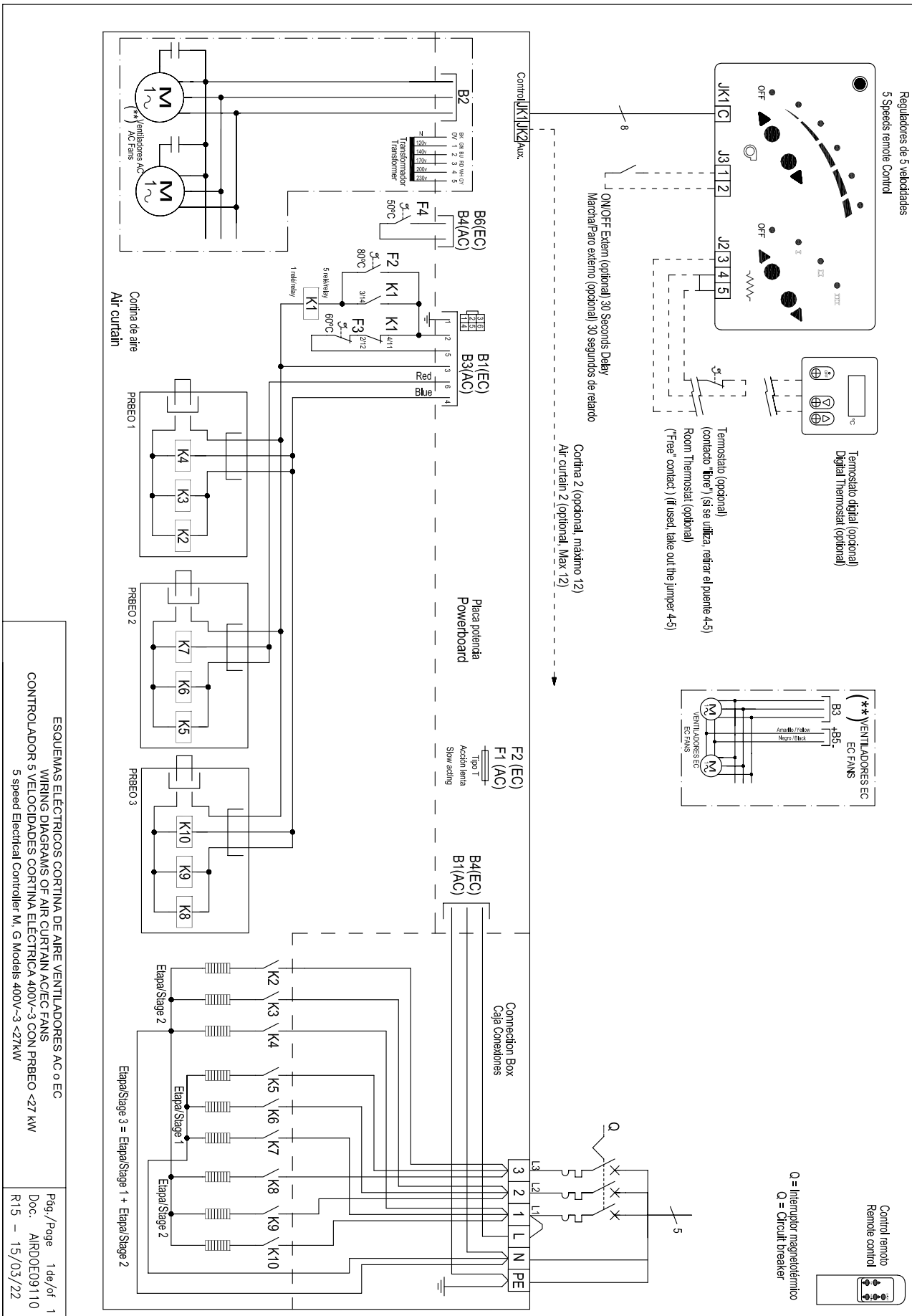

In case there is a need to connect the curtain to a PLC, the corresponding diagram is attached

30kW electric curtain with standard regulator (AIRDOE09101)

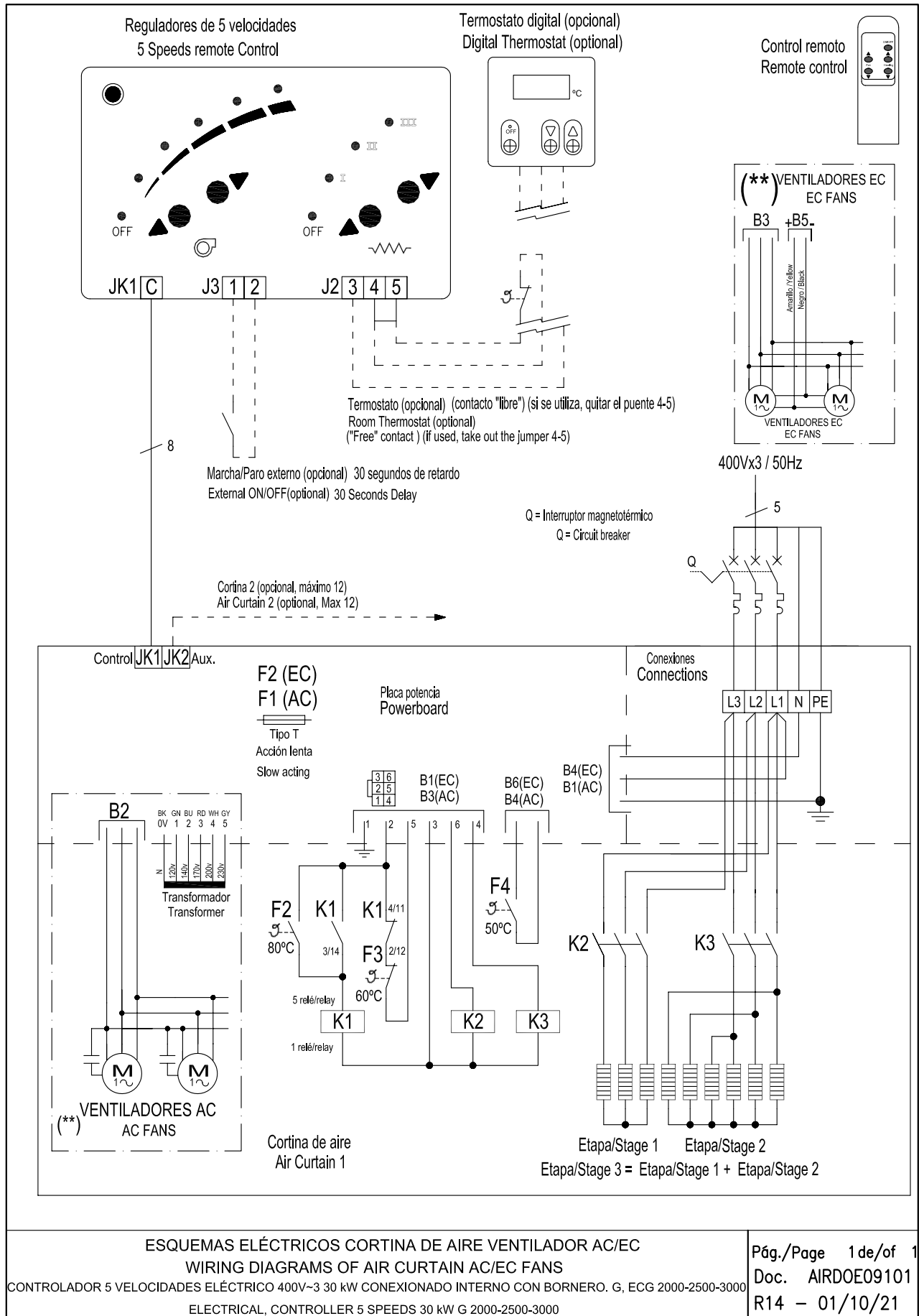

In case there is a need to connect the curtain to a PLC, the corresponding diagram is attached

DATA SHEET

ZEN | Decorative Air Curtains For Commercial Doors

Characteristics



- Decorative air curtain in contemporary architectural style. Its minimalist and smart design integrates in any environment and offers infinite options to customize.
- Can include personalized logotypes, signs or graphic designs. It can even incorporate clocks or lighting.
- Front anodized aluminium panels. Optionally manufactured in brushed or mirror polished stainless steel. Other materials are possible, such as wood, metal, etc.
- Central structure made of galvanized steel finished in black forge as standard. Other colours are available on request.
- Anodized aluminium outlet vanes, airfoil shaped, adjustable in both directions.
- Double-inlet centrifugal fans driven by an external rotor motor and low noise level. 5-speed selector. "EC" models with very low consumption efficient fans.
- "P" type with water heated coil. "E" type with electrical shielded elements, three stages with integrated regulation. "A" type without heating, air only. Optional "DX" with direct expansion coil.
- Includes Plug&Play control with 7m RJ45 cable and infrared remote control. Optional: Clever control (programmable, automatic, intelligent, energy saving, Modbus RTU for BMS...).

Specifications

AIR ONLY

Model	Airflow m ³ /h	Power Fans		Current Fans A	Noise Level (5m) dB(A)	Weight kg
		230V-50Hz kW	230V-50Hz			
ZEN M 1000 A	1980	0,318	1,41	55	32	
ZEN M 1500 A	2640	0,424	1,88	56	46	
ZEN M 2000 A	3960	0,636	2,82	57	62	
ZEN M 2500 A	4620	0,742	3,29	58	75	
ZEN G 1000 A	2400	0,642	2,85	57	36	
ZEN G 1500 A	3200	0,856	3,80	58	50	
ZEN G 2000 A	4800	1,284	5,70	59	69	
ZEN G 2500 A	5600	1,498	6,65	60	83	
ZEN ECG 1000 A	2700	0,213	1,86	61	36	
ZEN ECG 1500 A	3600	0,284	2,48	62	50	
ZEN ECG 2000 A	5400	0,426	3,72	63	69	
ZEN ECG 2500 A	6300	0,497	4,34	64	83	

ELECTRICAL HEATED

Model	Airflow m ³ /h	Electrical Heating Capacity		Power Fans 230V-50Hz kW	Current Fans A	Noise Level (5m) dB(A)	Weight kg
		400Vx3-50Hz kW	230V-50Hz				
ZEN M 1000 E	1980	3/6/9	0,318	1,41	55	40	
ZEN M 1500 E	2640	4/8/12	0,424	1,88	56	58	
ZEN M 2000 E	3960	6/12/18	0,636	2,82	57	77	
ZEN M 2500 E	4620	6/12/18	0,742	3,29	58	94	
ZEN G 1000 E	2400	5/10/15	0,642	2,85	57	43	
ZEN G 1500 E	3200	7,5/15/22,5	0,856	3,80	58	62	
ZEN G 2000 E	4800	10/20/30	1,284	5,70	59	85	
ZEN G 2500 E	5600	10/20/30	1,498	6,65	60	103	
ZEN ECG 1000 E	2700	5/10/15	0,213	1,86	61	43	
ZEN ECG 1500 E	3600	7,5/15/22,5	0,284	2,48	62	62	
ZEN ECG 2000 E	5400	10/20/30	0,426	3,72	63	85	
ZEN ECG 2500 E	6300	10/20/30	0,497	4,34	64	103	

WATER HEATED

Model	Airflow m ³ /h	P86		P64		P54		Power Fans 230V-50Hz kW	Current Fans A	Noise Level (5m) dB(A)	Weight kg
		Heating Capacity 80/60°C kW	Water Drop Pressure 80/60°C Pa	Heating Capacity 60/40°C kW	Water Drop Pressure 60/40°C Pa	Heating Capacity 50/40°C kW	Water Drop Pressure 50/40°C Pa				
ZEN M 1000 P	1860	9,84	1000	9,22	4990	-	-	0,318	1,41	55	37
ZEN M 1500 P	2480	14,23	760	13,65	6430	-	-	0,424	1,88	56	53
ZEN M 2000 P	3720	22,17	2190	19,70	5470	-	-	0,636	2,82	57	71
ZEN M 2500 P	4340	27,69	4000	23,48	4060	-	-	0,742	3,29	58	86
ZEN G 1000 P	2250	11,04	1230	10,42	6190	10,56	1790	0,642	2,85	57	40
ZEN G 1500 P	3000	16,02	940	15,47	8020	16,37	5670	0,856	3,80	58	57
ZEN G 2000 P	4500	24,92	2700	22,29	6810	23,15	3030	1,284	5,70	59	78
ZEN G 2500 P	5250	31,16	4930	26,61	5060	28,76	5450	1,498	6,65	60	95
ZEN ECG 1000 P	2550	11,89	1400	11,27	7110	11,50	2090	0,213	1,86	61	40
ZEN ECG 1500 P	3400	17,29	1070	16,77	9240	17,86	6620	0,284	2,48	62	57
ZEN ECG 2000 P	5100	26,86	3080	24,14	7850	25,24	3530	0,426	3,72	63	78
ZEN ECG 2500 P	5950	33,63	5650	28,84	5840	31,38	6360	0,497	4,34	64	95

Water heated: connection pipes P86 and P64 are 2x3/4" female (male if lateral pipes), P54 2x1" male. P86 2 rows coil, P64 3 rows coil, P54 4 rows coil.

ZEN | Decorative Air Curtains For Commercial Doors

Dimensions

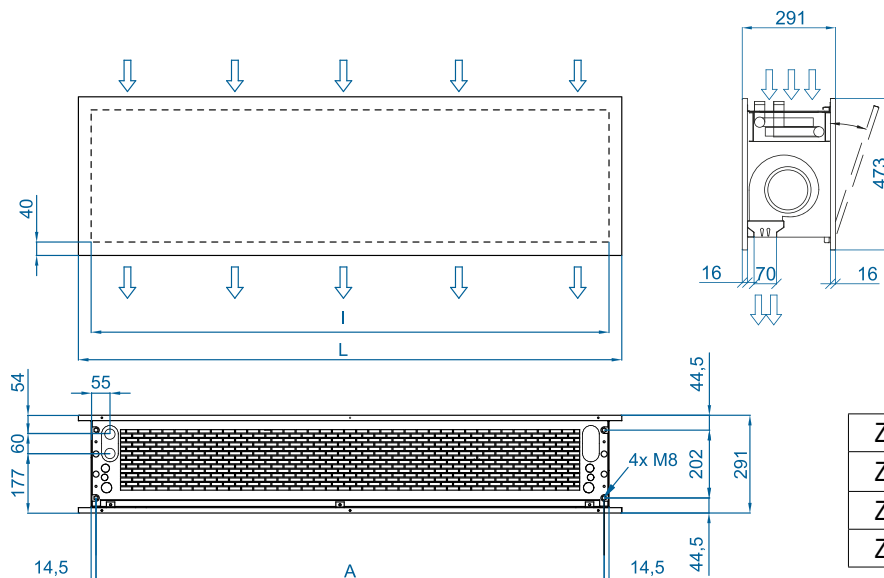

	L	I	A
ZEN 1000	1220	1140	1115
ZEN 1500	1620	1544	1515
ZEN 2000	2120	2044	2015
ZEN 2500	2620	2544	2515

Finishes





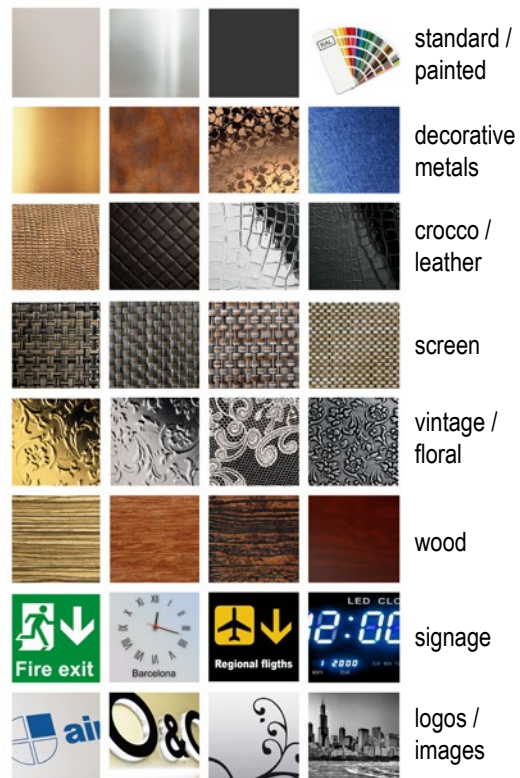

Vertical installation



- Painted any RAL colour or metal
- Different materials: aluminium, stainless steel AISI 304 (brushed or polished), wood, glass, PVC/PES, etc.
- Logos, lights, clocks, signs, vinyls, patterns, etc.



MAINTENANCE INSTRUCTIONS

	device from the current.
 	Do not open the service door (risk of electric shock and entrapment in the fans). Repairs must be carried out exclusively by authorized personnel.
	The inside of the device must not be cleaned with water or steam.

Indicative periodicity of maintenance

N° Action	Action	Frequency
1	Cleaning of the suction grill	Bi-monthly (recommended monthly)
2	Exterior cleaning	Half yearly (quarterly recommended)
3	Interior cleaning	Half yearly (quarterly recommended)
4	Internal inspection	Biannual (recommended annual)
5	Consumption and auditory control	Biannual (recommended annual)
6	Water heating maintenance	Half yearly (quarterly recommended)
7	Electrical heating maintenance	Half yearly (quarterly recommended)

Inlet grille cleaning

The suction grill prevents the entry of objects into the internal elements. It is a good idea to periodically check

Inlet grill cleaning

The suction grill prevents the entry of objects into the internal elements. It is a good idea to periodically check that the suction grille is free of any object that could block air from entering (plastic bags, paper, etc.).

It is recommended to clean the suction grill monthly.

In addition, it is important to make sure that the air curtain is off, otherwise the mixture between the dust and a damp cloth would form a paste of dirt that could damage the fan rotor when it sucks in the air or clog the water coil.

An annual cleaning of the discharge area must be carried out.



Exterior cleaning

Wipe the entire outer surface of the air curtain (except the suction grille) with a damp cloth to trap dust particles. In addition to the damp cloth, neutral soaps that do not contain acids or are caustic can be used.



Interior cleaning

It is recommended to clean the inside of the unit with a vacuum cleaner at least once every 2 years. (*) It is recommended to clean the inside of the equipment frequently with the help of a vacuum cleaner, especially before the arrival of winter. (*)

(*) These periods are indicative depending on the conditions of each installation. In places with a high number of suspended particles, it is desirable to increase the frequency of interior cleaning.



Internal components visual inspection

Check that the regulation board(s) have not suffered any damage and that they are securely fastened to the equipment frame. Make sure that the board and internal wiring connectors are still well connected. Check that the fans do not move from their mountings and check that the turbines have no impediments to rotate freely (turn it by hand, first turn off the device).



Air curtain consumption and auditory control checking

Write down the consumption value of the fans that appears on the product label (located on the inside of the service door). Give power to the curtain and with the help of an ammeter, check that the electrical consumption of the curtain at maximum speed is between 110% and 85% of the value indicated on the label. Check that all fans blow air. Keep the curtain at full speed for a few minutes and listen for abnormal noises from the curtain.



Heating maintenance

To ensure good heat transmission in the air curtain exchanger, it is recommended to check the heating coils as follows:

Coil cleaning

With both electric coils and water coils, the coil must be cleaned periodically with pressurized air.

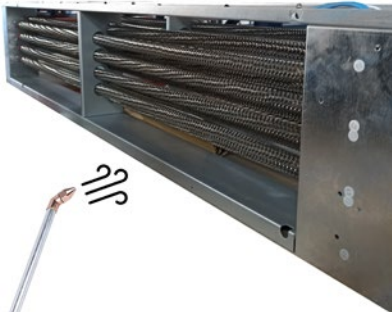

Water coils

Check the inlets and outlets of the water tubes to ensure that there are no fluid leaks.



If a water leak has been detected in the battery, possible corrosion problems in both the battery and the curtain components should be checked.



Electrical battery

Check that no cable has been disconnected from the battery circuit:



Resistance connection type for models M in all its lengths and Models G-ECG in lengths 1000 - 1500.

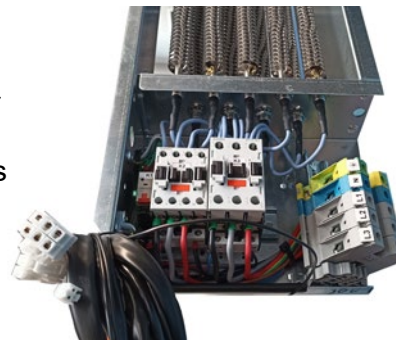

Resistance connection type for models G - ECG in lengths 2000 - 2500.

To verify the correct operation of the component, check the battery consumption per heating stage. Theoretical consumptions are shown below:

Air curtain size	Heating stage	M model		G - ECG models	
		Power by size and heating stage (kW)	Theoretical consumption (A) 400Vx3	Power by size and heating stage(kW)	Theoretical consumption (A) 400Vx3
1000	1	3	4,3	5	7,2
	2	6	8,7	10	14,4
	3	9	13	15	21,7
1500	1	4	5,8	7,5	10,8
	2	8	11,5	15	21,7
	3	12	17,3	22,5	32,5
2000	1	6	8,7	10	14,4
	2	12	17,3	20	28,9
	3	18	26	30	43,3
2500	1	6	8,7	10	14,4
	2	12	17,3	20	28,9
	3	18	26	30	43,3

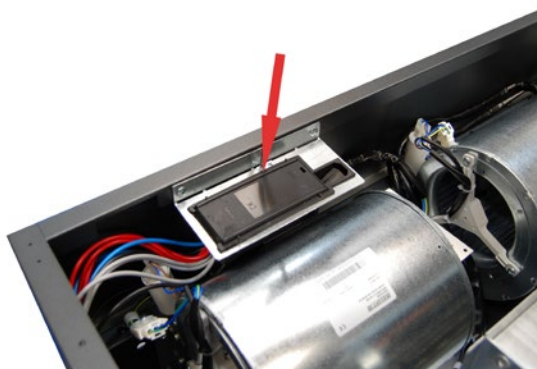

REPAIRS AND REPLACEMENTS

Assembly and electrical connection must be carried out exclusively by specialized professionals and in compliance with these instructions.

Before carrying out any repair, it is necessary to:



- **Notify staff and indicate that work is being done.**
- **Disconnect the current and protect the circuit breaker.**



- **Be sure there is no voltage in the unit.**



- **Be sure the fans have stopped.**
- **Use only original spare parts.**



CODE	COMPONENT	COMPONENT REFERENCE	AIR CURTAIN MODEL
TERCCO33320	Air Windbox 5 speed PCB	PAR-05V-W	M - G : Air
TERCCO33322	Electrical Windbox 5 speed PCB	PER-05V-W	M - G: Electrical
TERCCO33315	Water Windbox 5 speed PCB	PWR-05V-W	M - G: Water (P86, P64, P54)
VERCCO33700	Electrical EC Windbox 5 speed PCB	PEE-05V-W	ECG: Air and electrical
VERCCO33705	Water EC Windbox 5 speed PCB	PWE-05V-W	ECG : Water (P86, P64, P54)
AIRSEC99205	2 poles AC centrifugal fan	2GDS35 133X190L P15-A3 AC	G: All models
AIRSEC99215	4 poles AC centrifugal fan	4GDS35 146X188 N46-A1 AC	M: Air and electrical
AIRSEC99210	EC centrifugal fan	GDSG9 146X188R N46-A0 EC	ECG: All models
VERCCO33025	Air WINDBOX M,G 5 speed regulator IR receptor	CA - 5AW - IR	G , M : Air
VERCCO33005	Water WINDBOX M,G 5 speed regulator IR receptor	CW - 5AW - IR	G , M : Water (P86, P64, P54)
VERCCO33010	Electrical WINDBOX M,G 5 speed regulator IR receptor	CE - 5AW - IR	G , M: Electrical

Service door opening

ZEN model

1. Remove the two safety screws from the top of the curtain. Open the service panel with both hands. If necessary, remove the two safety cables and remove the panel by sliding it to one side of the shade.

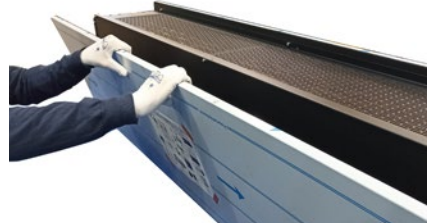

Fan replacement

Before changing the fan, notify and indicate that it is working, disconnect the power supply, making sure that there is no voltage and that the fans have stopped.

Next, identify and release the fan cables. Remove the fan by loosening the four fixing screws (one on each side) and mount the replacement fan following the process in reverse order.

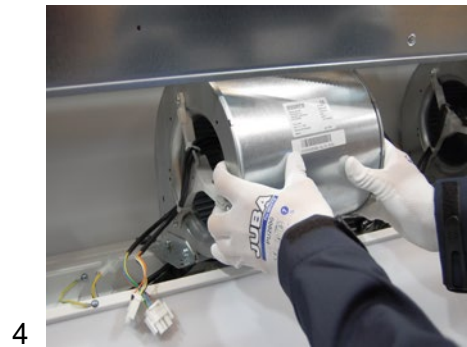
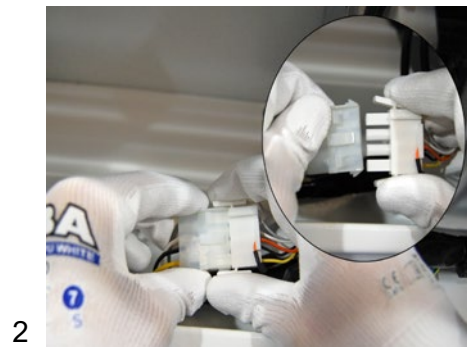

Replacement of the power board or fuse

Before changing the power board or fuse, notify and indicate that work is being done, disconnect the power supply, make sure that there is no voltage and that the fans have stopped.

Fuse changing: open the service door and remove the fuse by hand or with the help of a screwdriver by pressing towards the board, turning it counterclockwise. In some cases, it is recommended to unscrew the PCB.

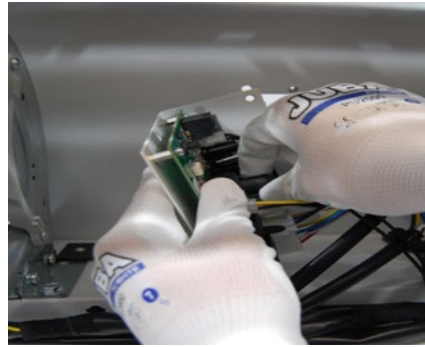
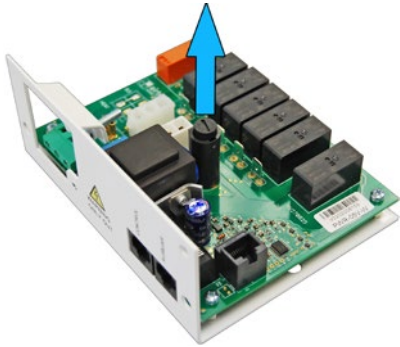

Power board change: open the service door and unscrew the power board from the inside of the air curtain to remove the plate and carry out the necessary repair.



Recommendation: installation with silentblocks

To reduce the sound level and the vibrations of the curtain, it is recommended to carry out an installation with silentblocks:

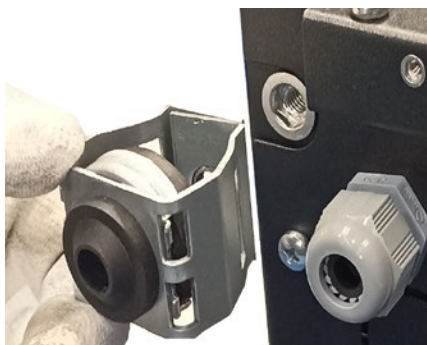

Battery replacement

Water batteries: close the building's water inlet and outlet valves up to the air curtain. Open the suction grille and drain the water coil with the drain plug of the main collector as shown in the photograph and disconnect the coil from the installation.

Warning! The curtain is not ready to work in cold mode. Do not circulate cold water through the battery. Before changing the battery, notify and indicate that you are working, disconnect the power supply, make sure that there is no voltage and that the fans have stopped. Before removing the screws that secure the battery:

1. Remove the battery suction grille.

Remove the rubber plug and the suction grille screws :



Lift and slide the suction grille to one side to remove it :

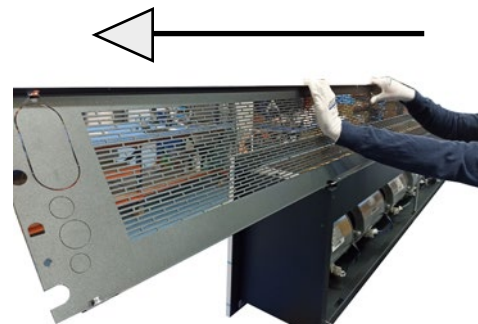
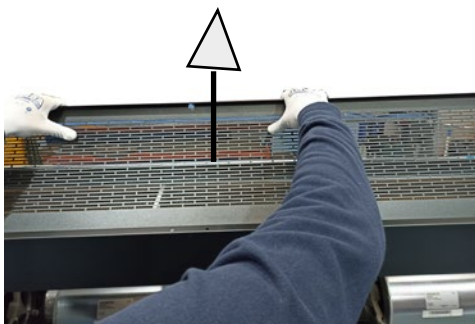

2. Remove the union phase and the sides of the curtain by removing the corresponding screws:

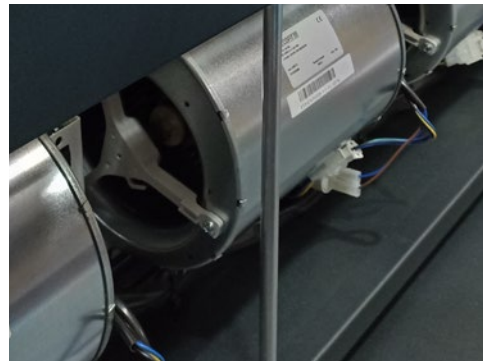
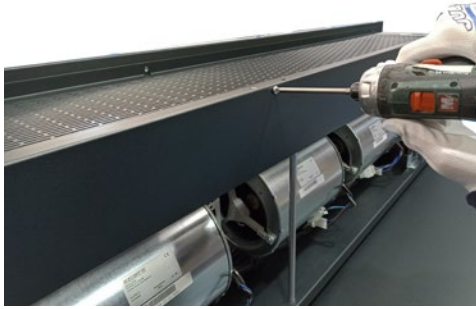

3. Remove the screws and fixing angles of the battery.

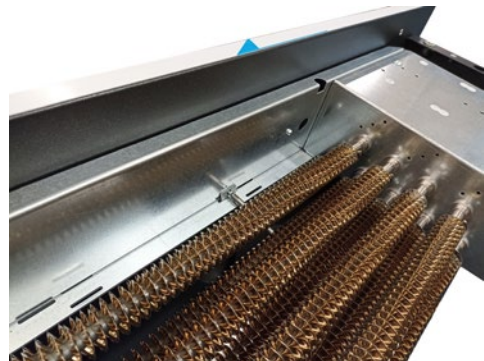
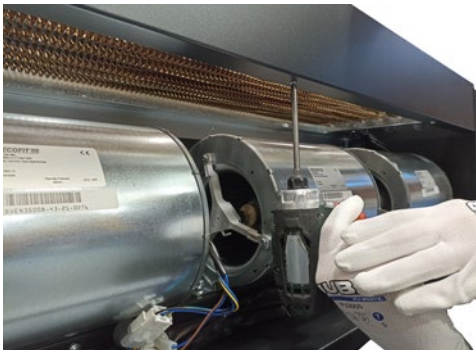

4. Empty the battery.



Electrical coils:

1. Disconnect the power supply from the battery itself by unscrewing the two screws on the connection box:

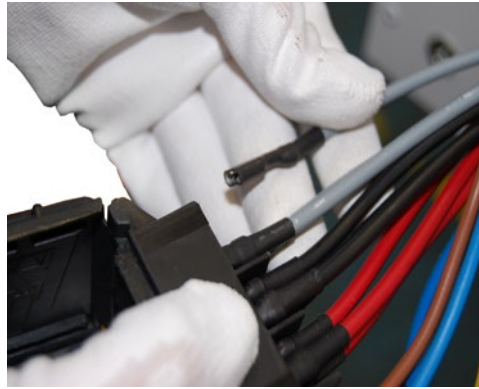
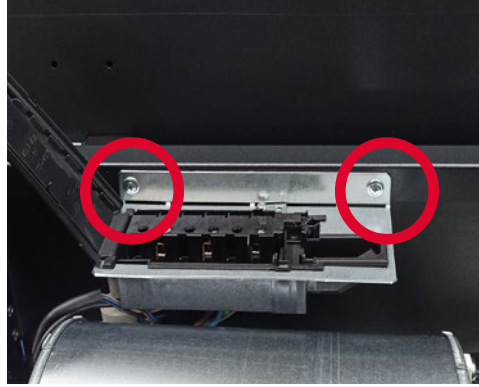

2. Remove the screws and fixing angles of the battery.

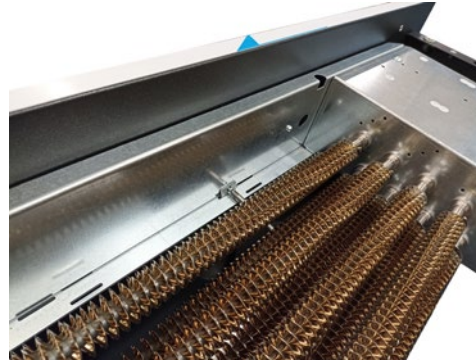
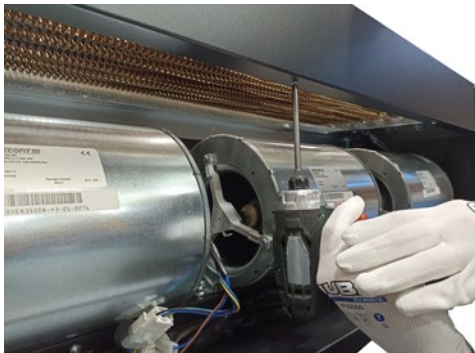

Air curtain size	N° lateral fixing angles
1000	1
1500	2
2000	3
2500	4

TROUBLESHOOTING

More than **95% of the claims** occur during the start-up of the equipment and are due to installation errors. Reviewing the following 3 points solves more than 90% of the incidents:

A) RJ45 cable manipulated: the cable connecting the control to the air curtain is an 8-way crossover RJ45 cable. If it is manipulated (cut or remove the connector) and spliced backwards, the shade will not work properly and may also damage the electronics. Only re-splicing the connector correctly solves the problem (connection diagram).

B) RJ45 cable wrong connection. Check if the position of the connector is correct between “control” or “auxiliary” according to the installation diagram (especially if there is more than one air curtain with a single controller).

C) Incorrect power supply. The supply of the air curtain depends on the type of current available and the type of heating of the equipment. Connect following the diagram scheme.

Most commons problems and solutions		
Symptom	Problem	Solution
No light on remote control	Is the RJ45 cable the original without splices or shortening?	Change the cable or reconnect it correctly.
	Does the current reach the connection box?	Correctly connect the terminals of the connection box: Between L and N there must be 230V. If the curtain has a three-phase electric battery, there must be 400V between terminals L1, L2 and L3.
	Is the control connected to the “Control” connector on the board?	Connect the control cable to the “Control” connector on the board (printed circuit), never to the “Aux”.
	Is the fuse on the board in good condition?	Check the fuse and change it if necessary (type T, slow action).
Some lights on the remote control flash	The green maximum speed LED flashes when the curtain stops after having been running with heating	It is not a bug, but a security mechanism. The curtain runs at full speed to cool down and protect components. When it drops below the safety temperature it will stop
	Speed or heating lights flash with the air curtain running	<p>It is a protection mechanism for the curtain so that the internal components are not damaged.</p> <p>Situations in which the problem is continually repeated and how to avoid them:</p> <ol style="list-style-type: none"> 1. Clogged suction grille (dirt, objects...) the temperature of the air inside the equipment can increase a lot if it does not circulate correctly. Keep the fence clean. 2. Small room size: it is recommended to install a thermostat to regulate the heating power without the protection being activated. 3. If the ambient temperature of the room is high, it is recommended to lower the heating power or install a thermostat 4. Suction of already hot air coming from a heating equipment outside the air curtain. Move the curtain away, put a thermostat on the suction or lower the heating power. 5. Some motor does not work: notify the technical service.
The heating does not work	Does the triphasic current reach the connection box?	Check installation.
The speed and/or the heating vary constantly for no apparent reason but the control lights do not flash	Surely the telephone type cable passes near sources of interference, emitters, cable trays, especially those that feed motors, etc.	Run the cable as far away as possible from sources of interference (especially on long runs) or use a shielded cable

ACCESSORIES



Clever Control

Smart proactive regulation, advanced functions, automatic/manual operation, door delay, time programmer, energy saving modes, multi-device management, BMS Modbus connection, etc.



External temperature probe

Allows you to take the temperature in a different place than the one the regulator is.



Interface II

Allows connection to a centralized management system (BMS, PLC, etc).



5 speed Hand Auto (water coil)

It allows to connect antifreeze sensor, door contact, room thermostat.



Digital thermostat

It allows to modify the heating stages and/or the speed of the air depending on the temperature and the chosen program.



Ambient Thermostat

Limits heating operation to the selected temperature.

Supports feet, silentblocks, etc. (depending on model).



Door contact, thermostatic valve, solenoid valve, antifreeze sensor, etc..

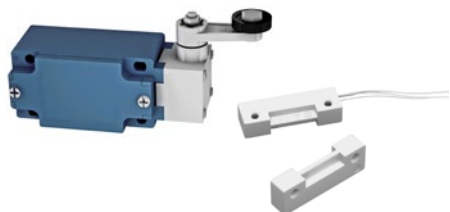



RJ45 cable 20m y 50m.



DECLARATION OF CONFORMITY



Declaration  of conformity / Declaración  de conformidad

Manufacturer **Motors i Ventiladors S.L. (AIRTÈCNICS)**
Fabricante **Conca de Barberà 6, Pol. Ind. Pla de la Bruguera**
08211 Castellar del Vallès (Barcelona) Spain

We declare, under our sole responsibility, that the product
Declaramos, bajo nuestra única responsabilidad, que el producto

Air Curtains
Cortinas de aire

with models / *con los modelos*

Minibel, Optima, Recessed Optima, Optima Wireless, Recessed Optima Wireless, Windbox, Recessed Windbox, Smart, Dam, Deco, Kool, Variwind, Rotowind, Invisair, Rund, Zen, Triojet System, Duojet, Max, Recessed Dam, Recessed Compact, Maxwell, Windbox BB, Recessed Windbox BB, Zen BB, Compact Fly, Aris, Fly K, Fly KL-KXL, Fly KBB, Windbox L-XL.

is/are developed, designed and manufactured in accordance with the following directive(s)
ha(n) sido desarrollado(s), diseñado(s) y fabricado(s) de acuerdo con la(s) siguiente(s) directiva(s)

Low Voltage Directive 2014/35/EU
Directiva Baja Tensión 2014/35/UE

Electromagnetic Compatibility Directive 2014/30/EU
Directiva Compatibilidad Electromagnética 2014/30/UE

Restriction Certain Hazardous Substances Directive 2011/65/EU (RoHS)
Directiva Restricción Substancias Peligrosas 2011/65/UE

Eco-design Energy-related Products Directive 2009/125/EC
Directiva Diseño Ecológico Productos Con Energía 2009/125/CE

applying the following harmonized standards in particular
aplicando las siguientes normas armonizadas en particular

LVD: EN 60335-1:2012 + AC:2014 + A11:2014 + A13:2017 + A1:2019 + A:14:2019 + A2:2019
EN 60335-2-30:2009 + A11:2012 + A1:2020 + A12 :2020

EMC: EN 61000-3-11:2002
EN 61000-3-12:2012
EN 55014-1:2017
EN 55014-2:2015
EN 62233:2008 + AC:2008

RoHS: EN 50581:2012

Date / Fecha
Name / Nombre
Position / Cargo

03/12/2021
Jordi Hierro
Technical Manager / Director Técnico

MOTORS I VENTILADORS, S.L.
ESB58967183 - C/ Conca de Barberà, 6
08211 Castellar del Vallès
Tel. 937159988 - Fax 937159989

**UK
CA****UK Declaration of conformity**

Manufacturer **Motors i Ventiladors S.L. (AIRTÈCNICS)**
Conca de Barberà 6, Pol. Ind. Pla de la Bruguera
08211 Castellar del Vallès (Barcelona) Spain

We declare, under our sole responsibility, that the product

Air Curtains

with models

Minibel, Optima, Recessed Optima, Optima Wireless, Recessed Optima Wireless, Windbox, Recessed Windbox, Smart, Dam, Deco, Kool, Variwind, Rotowind, Invisair, Rund, Zen, Triojet System, Duojet, Max, Recessed Dam, Recessed Compact, Maxwell, Windbox BB, Recessed Windbox BB, Zen BB, Compact Fly, Aris, Fly K, Fly KL-KXL, Fly KBB, Windbox L-XL.

is/are developed, designed and manufactured in accordance with the following regulation(s)

Electrical Equipment (Safety) Regulations 2016 No. 1101

Electromagnetic Compatibility Regulations 2016 No. 1091

The Restriction of the Use of Certain Hazardous Substances in Electrical and Electronic Equipment Regulations 2012 No. 3032

The Ecodesign for Energy-Related Products and Energy Information (Amendment) (EU Exit) Regulations 2019 No. 539

applying the following harmonized standards in particular

LVD: BS EN 60335-1:2012+A2:2019
BS EN 60335-2-30:2009+A12:2020

EMC: BS EN IEC 61000-3-11:2019
BS EN 61000-3-12:2011
BS EN IEC 55014-1:2021
BS EN IEC 55014-2:2021

RoHS: BS EN IEC 63000:2018

Date
Name
Position

14/06/2021
Jordi Hierro
Technical Manager



MOTORS I VENTILADORS, S.L.
ESB58967183 - C/ Conca de Barberà, 6
08211 Castellar del Vallès
Tel. 937159988 - Fax 937159989

Conca de Barberà, 6 - Pol. Ind. Pla de la Bruguera
E-08211 Castellar del Vallès (Barcelona) Spain
☎ + 34 93 715 99 88
airtecnicos@airtecnicos.com

www.airtecnicos.com



AIRDOM05081-R15(09/24)

Airtècnics reserves the right to modify some of the specifications in this manual.