

Características técnicas



Alcance máximo

M : 3,5 m ECM : 3,8 m
G : 4 m ECG : 4,2 m



Caudal / Longitud

1860 - 7200 m³/h
1 m a 3 m



Ventiladores

Centrífugos
5 velocidades



Tipo de calefacción

E : eléctrica 3 etapas
P : agua
A : sin calefacción
DX : bomba calor [*]



Potencia calorífica

E : 3 - 30 kW
P : 9,2 - 40,3 kW



Control

Plug&Play Advanced Pro
+ control remoto IR
(Control Clever opcional)

Facetado / Liso

RAL estándar 9006 / 9016

Inox cepillado / Pulido

Otros colores y materiales bajo pedido

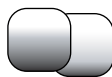
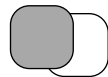
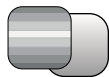

Bastidor [**]

Acero galvanizado
(Facetado o liso)



Tipo de reja

Perforado circular



Lamas de descarga

Aluminio, tipo airfoil
Ajustable 0-15° cada lado

[*] Consultar catálogo DX

[**] Bajo pedido, medidas personalizables

RUND es una cortina de aire decorativa cilíndrica, elegante y exclusiva. Instaladas verticalmente a uno o ambos lados de la puerta u horizontalmente sobre la entrada de forma individual o múltiple, las cortinas de aire RUND se integran perfectamente en el entorno como elemento arquitectónico de columna. Amplia gama de accesorios y configuraciones disponibles para adaptarse a cualquier necesidad que requiera la instalación. Dispone de múltiples acabados que la convierten en la solución decorativa adecuada para cualquier proyecto de interiorismo. Disponible en dos acabados de bastidor diferentes (facetado o completamente liso).

Este modelo de cortina de aire funciona con ventiladores centrífugos de doble aspiración con motores de rotor externo de bajo nivel sonoro. Los modelos "EC" incorporan ventiladores eficientes de muy bajo consumo.

Control Plug&Play avanzado. Incluye: Control PRO avanzado con pantalla LCD y termostato integrado, contacto de puerta, cable RJ11 de 7 m y mando a distancia. Opcional: Control Clever PRO inteligente (automático, programable, modbus por PLC, temporizador, etc).

❄ SIN CALEFACCIÓN

Modelo	Caudal m³/h	Potencia ventilación 230V~50Hz kW	Intensidad ventilación 230V~50Hz A	Nivel sonoro (5 m) dB (A)	Peso kg
RUND M 1000 A	1980	0,318	1,41	55	42
RUND M 1500 A	2640	0,424	1,88	56	63
RUND M 2000 A	3960	0,636	2,82	57	79
RUND M 2500 A	4620	0,742	3,29	58	88
RUND M 3000 A	5280	0,848	3,76	59	99
RUND G 1000 A	2400	0,642	2,85	57	46
RUND G 1500 A	3200	0,856	3,80	58	68
RUND G 2000 A	4800	1,284	5,70	59	89
RUND G 2500 A	5600	1,498	6,65	60	98
RUND G 3000 A	6400	1,712	7,60	61	108
RUND ECG 1000 A	2700	0,213	1,86	61	46
RUND ECG 1500 A	3600	0,284	2,48	62	68
RUND ECG 2000 A	5400	0,426	3,72	63	89
RUND ECG 2500 A	6300	0,497	4,34	64	98
RUND ECG 3000 A	7200	0,568	5,96	65	108



⚡ CALEFACCIÓN ELÉCTRICA

Modelo	Caudal	Potencia calorífica eléctrica 400Vx3~50Hz (*)	Potencia ventilación 230V~50Hz	Intensidad ventilación 230V~50Hz	Nivel sonoro (5 m)	Peso
	m³/h	kW	kW	A	dB(A)	kg
RUND M 1000 E	1980	3/6/9	0,318	1,41	55	49
RUND M 1500 E	2640	4/8/12	0,424	1,88	56	75
RUND M 2000 E	3960	6/12/18	0,636	2,82	57	97
RUND M 2500 E	4620	6/12/18	0,742	3,29	58	108
RUND M 3000 E	5280	8/16/24	0,848	3,76	59	119
RUND G 1000 E	2400	5/10/15	0,642	2,85	57	54
RUND G 1500 E	3200	7,5/15/22,5	0,856	3,80	58	81
RUND G 2000 E	4800	10/20/30	1,284	5,70	59	107
RUND G 2500 E	5600	10/20/30	1,498	6,65	60	118
RUND G 3000 E	6400	10/20/30	1,712	7,60	61	128
RUND ECG 1000 E	2700	5/10/15	0,213	1,86	61	54
RUND ECG 1500 E	3600	7,5/15/22,5	0,284	2,48	62	81
RUND ECG 2000 E	5400	10/20/30	0,426	3,72	63	107
RUND ECG 2500 E	6300	10/20/30	0,497	4,34	64	118
RUND ECG 3000 E	7200	10/20/30	0,568	5,96	65	128

(*) Bajo pedido, se pueden suministrar baterías eléctricas en otras potencias.

💧 CALEFACCIÓN AGUA

Modelo	Caudal m³/h	P86 (80/60°C)			P64 (60/40°C)		P54 (50/40°C)		Potencia ventilación 230V~50Hz kW	Intensidad ventilación 230V~50Hz A	Nivel sonoro (5 m) dB(A)	Peso kg
		Potencia calorífica kW	Pérdida presión agua Pa	Potencia calorífica kW	Pérdida presión agua Pa	Potencia calorífica kW	Pérdida presión agua Pa					
		RUND M 1000 P	1860	9,84	1000	9,22	4990	-				
RUND M 1500 P	2480	14,23	760	13,65	6430	-	-	0,424	1,88	56	71	
RUND M 2000 P	3720	22,17	2190	19,70	5470	-	-	0,636	2,82	57	90	
RUND M 2500 P	4340	27,69	4000	23,48	4060	-	-	0,742	3,29	58	101	
RUND M 3000 P	4960	33,15	6560	28,29	6730	-	-	0,848	3,76	59	112	
RUND G 1000 P	2250	11,04	1230	10,42	6190	10,56	1790	0,642	2,85	57	52	
RUND G 1500 P	3000	16,02	940	15,47	8020	16,37	5670	0,856	3,80	58	77	
RUND G 2000 P	4500	24,92	2700	22,29	6810	23,15	3030	1,284	5,70	59	100	
RUND G 2500 P	5250	31,16	4930	26,61	5060	28,76	5450	1,498	6,65	60	109	
RUND G 3000 P	6000	37,35	8110	32,10	8410	34,03	5450	1,712	7,60	61	119	
RUND ECG 1000 P	2550	11,89	1400	11,27	7110	11,50	2090	0,213	1,86	61	52	
RUND ECG 1500 P	3400	17,29	1070	16,77	9240	17,86	6620	0,284	2,48	62	77	
RUND ECG 2000 P	5100	26,86	3080	24,14	7850	25,24	3530	0,426	3,72	63	100	
RUND ECG 2500 P	5950	33,63	5650	28,84	5840	31,38	6360	0,497	4,34	64	109	
RUND ECG 3000 P	6800	40,34	9290	34,81	9710	37,16	8400	0,568	5,96	65	119	

Baterías de agua: las conexiones P86 y P64 son 2x3/4" hembra (macho si conexiones laterales), P54 2x1" macho. P86 2 filas. P64 3 filas. P54 4 filas.



Selection program

Dimensiones

Instalación horizontal

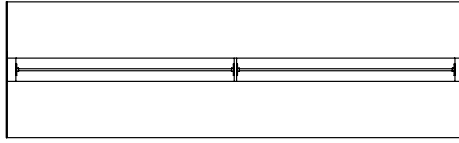

Bajo pedido, medidas personalizables

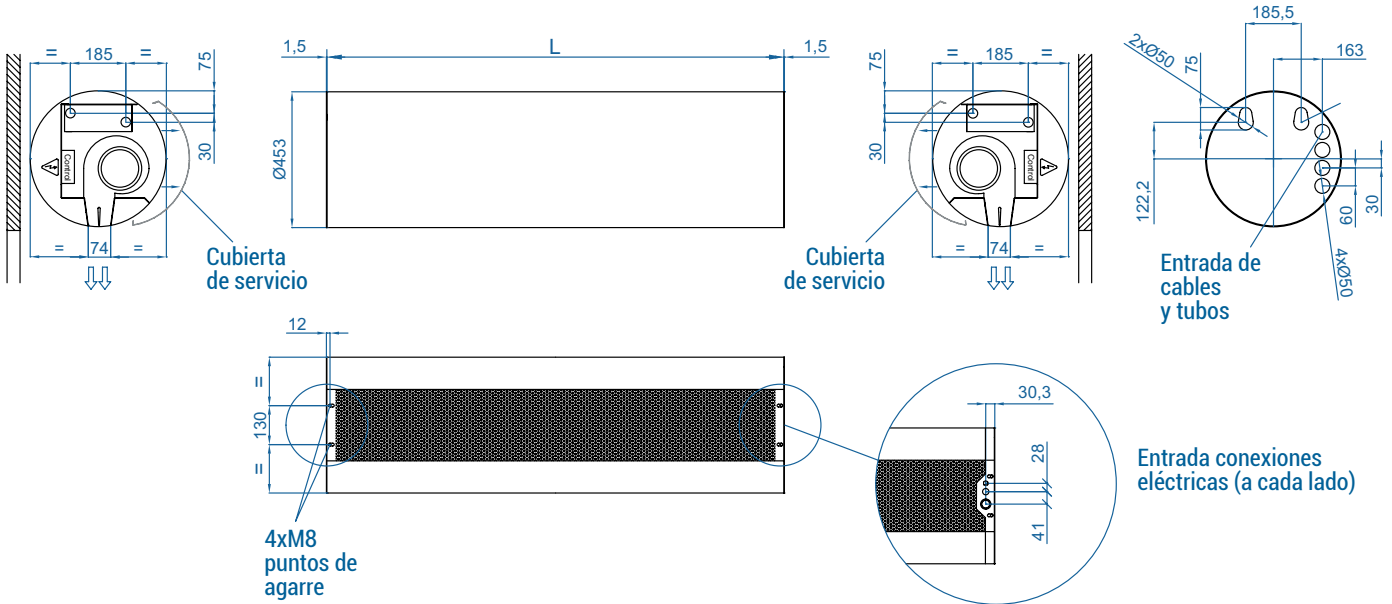

Instalación vertical

Pie de fijación a suelo

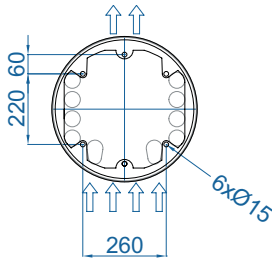

Entrada de cables y tuberías

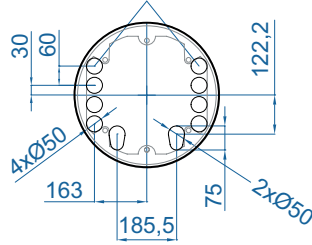

	L
RUND 1000	1025
RUND 1500	1525
RUND 2000	2030
RUND 2500	2530
RUND 3000	2980

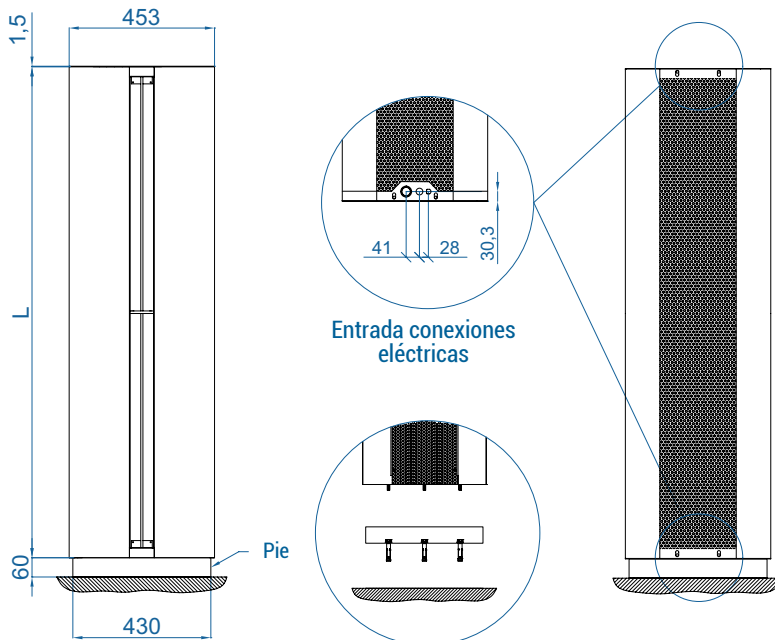

Planos CAD, archivos BIM, manuales de instalación y otra documentación



Configuraciones de instalación y acabados



VER CATÁLOGO
ACABADOS



VER VIDEO

Gran variedad de
acabados disponibles

Múltiples configuraciones
de instalación y soportes

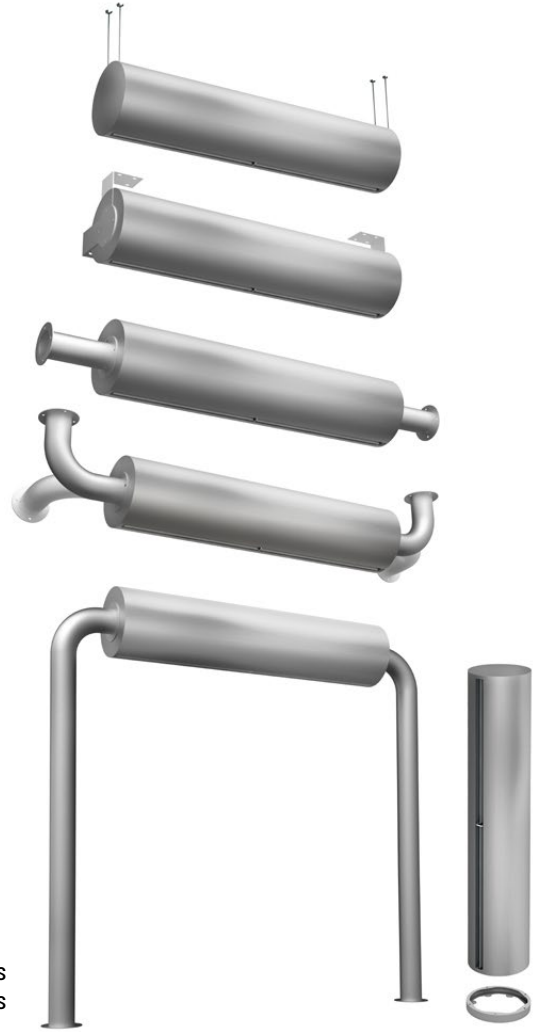

Accesorios opcionales

Soportes e instalación



Soportes rail
SPWR



Soportes silentblock
SPANG-SIL / SLB



Cables de
suspensión SPCT



Brazo recto 180°
Rund



Brazo curvo
Rund



Kit unión Rund
techo / pared



Soporte ángulo Rund
techo / pared



Soporte pie
SPF-Rund
(Galv. / inox)

Control



ADVANCED PRO
✓ Incluido



Control IR
✓ Incluido



RJ11 Cable
✓ Incluido



CLEVER PRO

Filtros



Prefiltro
extraíble G2

Sensores y válvulas



Contacto de puerta
magnético MAG-DC
✓ Incluido



Contacto de puerta
mecánico MEG-DC



Sensor temperatura
externa



Válvula solenoide
V-S



Válvula 3 vías
V-T



Válvula proporcional
V-ACT



Sensor anticongelación
AFS-INS