

## AIRBOX AIR HANDLING UNITS



**Airbox**

<sup>®</sup> **ECOFT**  
**rosenberg** **ETRI**  
THE AIR MOVEMENT GROUP



**Rosenberg Ventilatoren GmbH**

Maybachstr. 1/9  
D-74653 Künzelsau-Gaisbach  
Fon +49 (0)7940 / 142-0  
Fax +49 (0)7940 / 142-125

[www.rosenberg-gmbh.com](http://www.rosenberg-gmbh.com)  
[info@rosenberg-gmbh.com](mailto:info@rosenberg-gmbh.com)

<b>Introduction</b>	2-3
<b>Product range</b>	4
<b>Unit variants and recommended air velocities</b>	5
<b>Unit series according to air volumes and dimensions</b>	6-7
<b>Energy efficiency</b>	8
<b>Type codes</b>	9

<b>Airbox A20</b>	
Configuration and properties	10
Flow rates / panel and module connection	11
Module dimensions of the components	12-13
Connection dimensions	14

*Not available from January 2016!*

<b>Airbox F40</b>	
Configuration and properties	16
Flow rates / panel and module connection	17
Module dimensions of the components	18-19
Connection dimensions	20

<b>Airbox S40</b>	
Configuration and properties	22
Flow rates / panel and module connection	23
Module dimensions of the components	24-27
Connection dimensions	28-29

<b>Airbox S60</b>	
Configuration and properties	
Flow rates / panel and module connection	30
Module dimensions of the components	31
Connection dimensions	32-35
	36

<b>Airbox T60</b>	
Configuration and properties	38
Flow rates / panel and module connection	39
Module dimensions of the components	40-43
Connection dimensions	44

<b>Unit configurations</b> (weatherproof, hygiene configuration, ATEX )	46-51
<b>Unit components</b> (heat recoveries, fans, heaters, coolers, Humidifiers, silencers, multi-leaf dampers, connectors)	52-62
<b>Transport and installation options</b>	72-73
<b>Controlling systems</b>	74-76

# Tailor-made system solutions

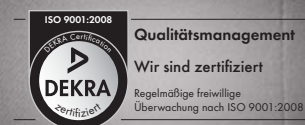

## Air handling units for all applications

The requirements on a ventilation system are not always the same. In many applications, all that is required, is a straightforward exchange of air, whereas in other applications the requirements can be very exacting, with regard to temperature, humidity and purity of the air. Rosenberg air handling units in the Airbox series have a modular design and can be individually configured. In this way, the appropriate solution can be assembled using a kind of modular

principle for each application, in a quick and straightforward procedure. Both, in the high-tech area and for classic building technology, air handling units from Rosenberg deliver clean air at the right condition. Weatherproof and explosion-proof configurations are possible, just as are ILH-certified hygiene variants. Air handling units in the Airbox series achieve energy efficiency category A+ and meet the most exacting requirements on efficiency and quality.

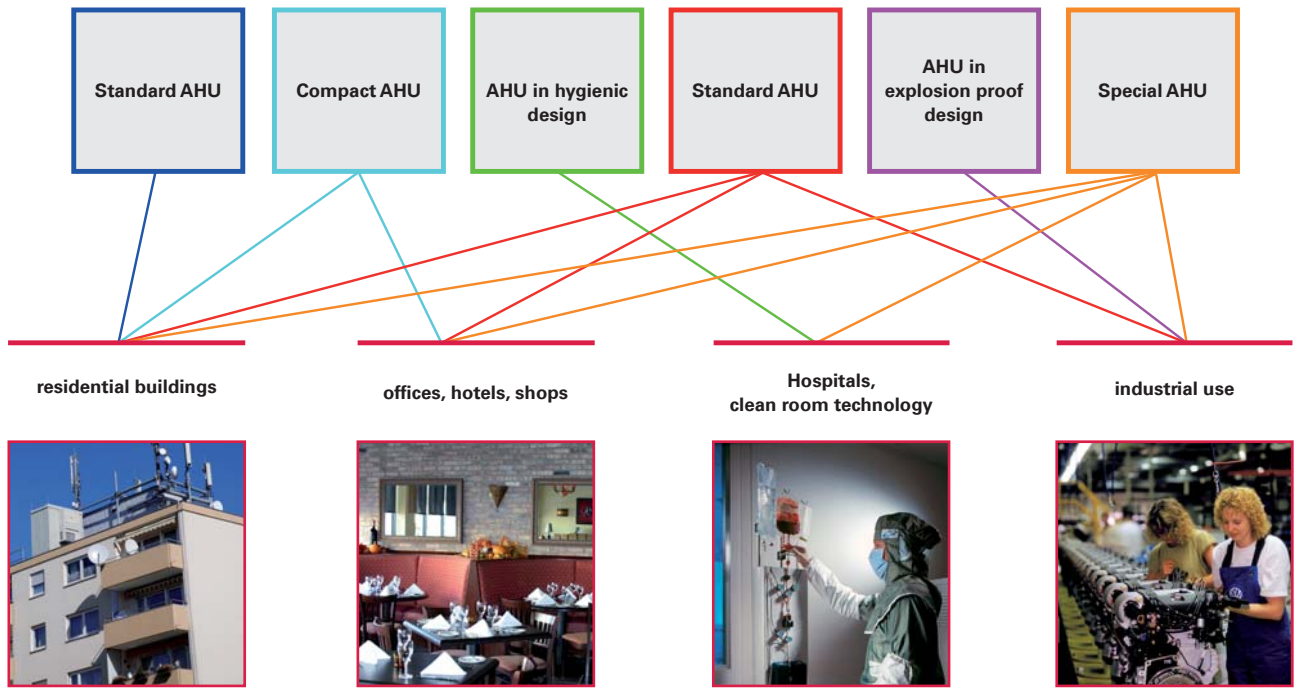

## Airbox air handling units in modular construction (series A20, S40, S60, T60)

The units consist of a framework structure with double-walled panels, that have acoustic and thermal insulation. The individual modules for the filter, fan, heater, cooler, heat recovery, acoustic insulation as well as the frame materials, are assembled flexibly according to the customers' requirements.



## Frameless Airbox air handling units (F40)

The F40 series is produced in a frameless design. The panels are screwed together from the outside, which means the units have a smooth surface on the inside and will be hygienic harmless.



## Compact air handling units (SupraBox COMFORT series / SupraBox DELUXE series)

Space-saving complete solution, with integrated controller for ventilation and exhausting, in only one unit. Ideally suited for showrooms, rooms for events and for schools. Simply plug & play connection, equipped with energy-saving EC technology. For more information, refer to our brochures „Compact ventilation units with heat recovery“.



## Overview of the various unit series:

The air handling units Airbox A20, S40, S60, T60 are equipped with a framework construction made from aluminium or galvanised, rolled steel profiles and aluminium cast corner connectors, or plastic corner connectors. The double-walled panels are equipped with insulation comprising non-flammable mineral wool, with acoustic and thermal insulating properties. In addition to galvanised steel panels and the framework con-

struction, it is also possible to select coated steel, aluminium and stainless steel versions in our range. For modules with smaller dimensions, the base frame is manufactured in various heights (100, 300, 500 mm) using galvanised, folded steel sheet. Larger modules have a welded base frame (primered or galvanised).

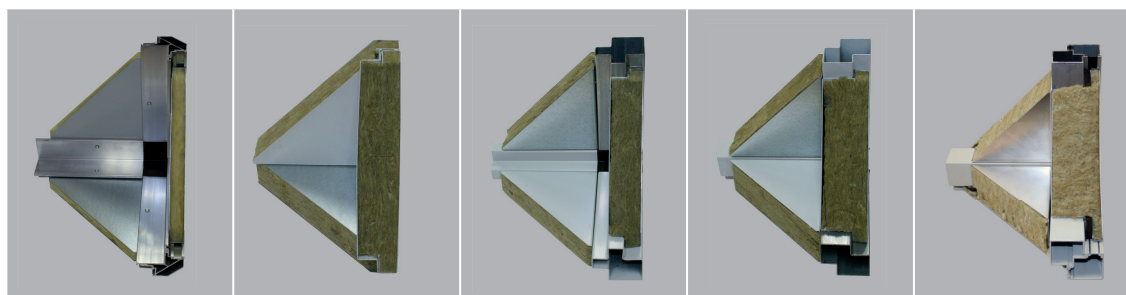

Unit Series	Airbox A20	Airbox F40	Airbox S40	Airbox S60	Airbox T60
thickness of panel	20 mm	40 mm	40 mm	60 mm	60 mm
Frame	3 mm aluminium profile	frameless	1,5 mm steel galvanized or stainless steel	1,5 mm steel galvanized	1,5 mm aluminium and thermally decoupled

Unit Series	Airbox A20	Airbox F40	Airbox S40	Airbox S60	Airbox T60
Indoor installation	✓	✓	✓	✓	✓
Outdoor installation		✓	✓	✓	✓
Hygienic design according VDI 6022-1		✓	✓	✓	✓
Hygienic design certified (DIN 1946-4)			✓	✓	✓
Explosion proof design (ATEX and GOST)			2G, 3G (2D, 3D) <sup>1</sup>	2G, 3G (2D, 3D) <sup>1</sup>	
Indoor swimming pool use					steel color coated, AlMg3, AISI 316
Direct fired air heater			✓	✓	(on request)
Vertical air stream	✓	✓	✓	✓	✓
Energy efficiency class labels (German AHU Manufacturers Association)		✓	✓	✓	✓
Eurovent		✓			✓

<sup>1</sup> on request

## Overview of recommend air velocities depending on unit category:

Unit category	Air velocity in unit face	classes of air velocity levels	Remarks
Exhaust air unit (without thermodynamic air treatment)	up to size 16Q max. 4,5 m/s from size 16Q bis 28R max. 4,0 m/s	V9	According to VDI 3803, a maximum air velocity of 8.0 m/s is permitted in connectors and dampers (except recirculation and bypass dampers).
Supply or exhaust air unit with filter and heater if necessary	max. 4,0 m/s	V9	A maximum of 4.0 m/s is permitted for most filter types. Heaters with low power are possible, with acceptable pressure loss.
Air handling unit with heat recovery, cooler, humidifier or other components	max. 2,5 m/s	V5	At higher air velocities, the pressure losses from heat recovery units and coolers increase massively, resulting in drastically rising energy input - and the associated higher lifecycle costs.
Air handling unit with vertical air ducting and components such as cooler and humidifier	Air direction upstream max. 2,0 m/s Air direction down stream max. 1,5 m/s	V3 V1	The droplet eliminator to be fitted under the cooling coil, requires the air velocity to be as slow as possible, in order for the condensate to be extracted reliably.
Optimum for all unit categories	max. 1,5 - 2,0 m/s	V1 - V3	In most cases, the lifecycle costs of the unit are minimal!
Minimum for all unit categories	up to size 10Q min. 0,7 m/s from size 13R min. 1,0 m/s	V1	If the air velocity is too low, it is possible for stratification of the air temperature to take place over the profile unit face. This can lead to negative effects in terms of comfort and controllability!

## Airbox A20

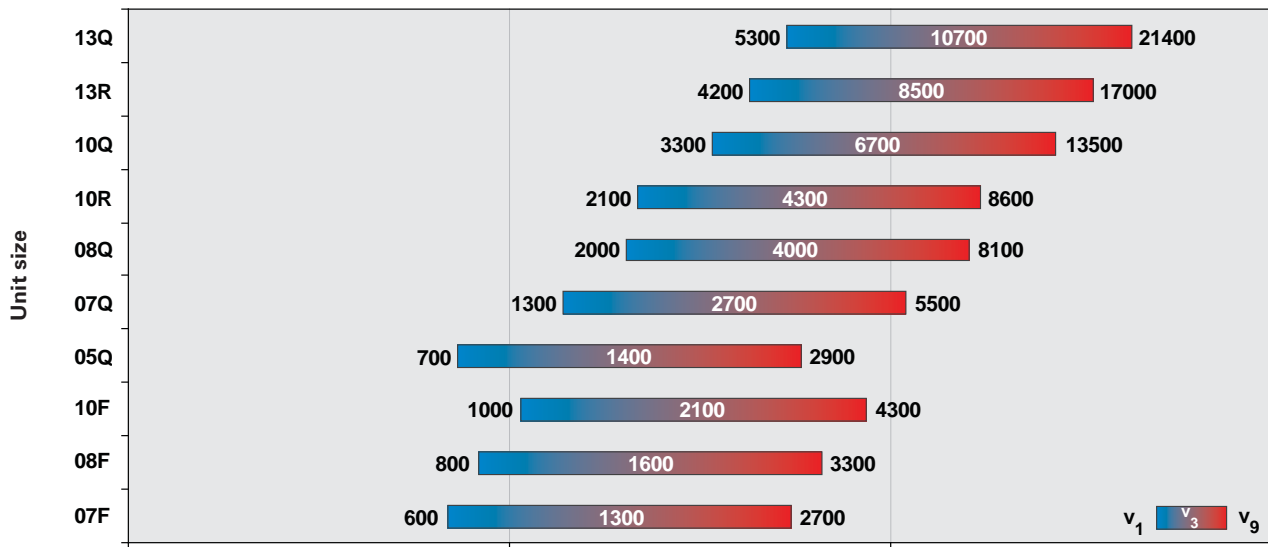

Air volume [m<sup>3</sup>/h]

Air velocity: min. (v<sub>1</sub>) 1m/s ; optimal (v<sub>3</sub>) 2,0 m/s ; max. (v<sub>9</sub>) 4,0 m/s

ext. dimensions	Flat Unit			Standard AHU						
	07F	08F	10F	05Q	07Q	08Q	10R	10Q	13R	13Q
<b>B</b> [mm]	670	800	1020	500	670	800	1020	1020	1270	1270
<b>H</b> [mm]	358	358	358	500	670	800	670	1020	1020	1270

## Airbox F40

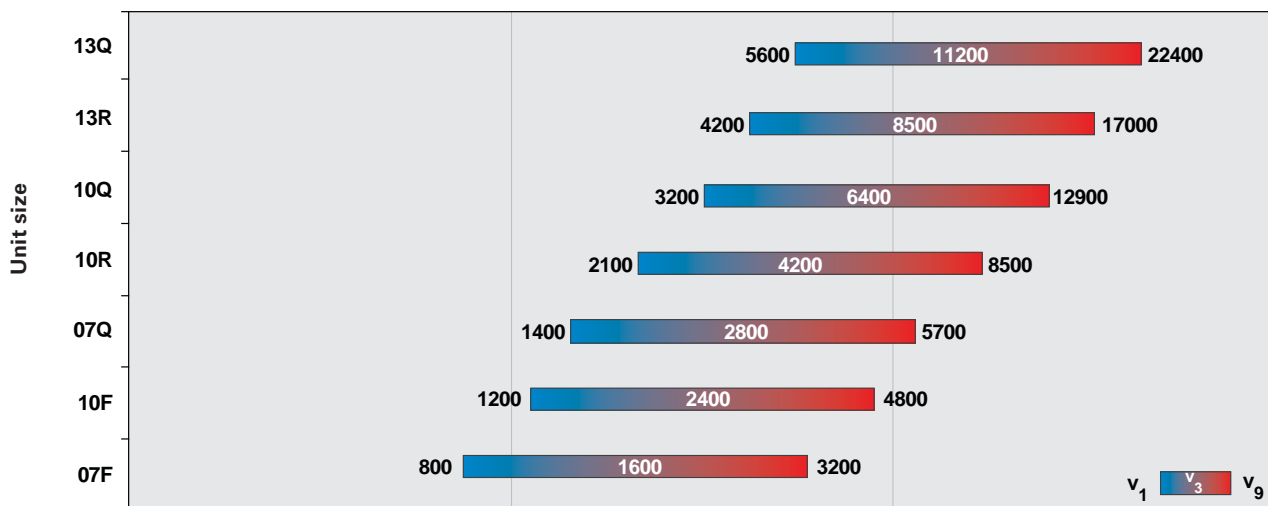

Air volume [m<sup>3</sup>/h]

Air velocity: min. (v<sub>1</sub>) 1m/s ; optimal (v<sub>3</sub>) 2,0 m/s ; max. (v<sub>9</sub>) 4,0 m/s

ext. dimensions	Flat Unit		Standard AHU				
	07F	10F	07Q	10R	10Q	13R	13Q
<b>B</b> [mm]	720	1040	720	1040	1040	1340	1340
<b>H</b> [mm]	450	450	720	720	1040	1040	1340

## Airbox S40 / S60 / T60

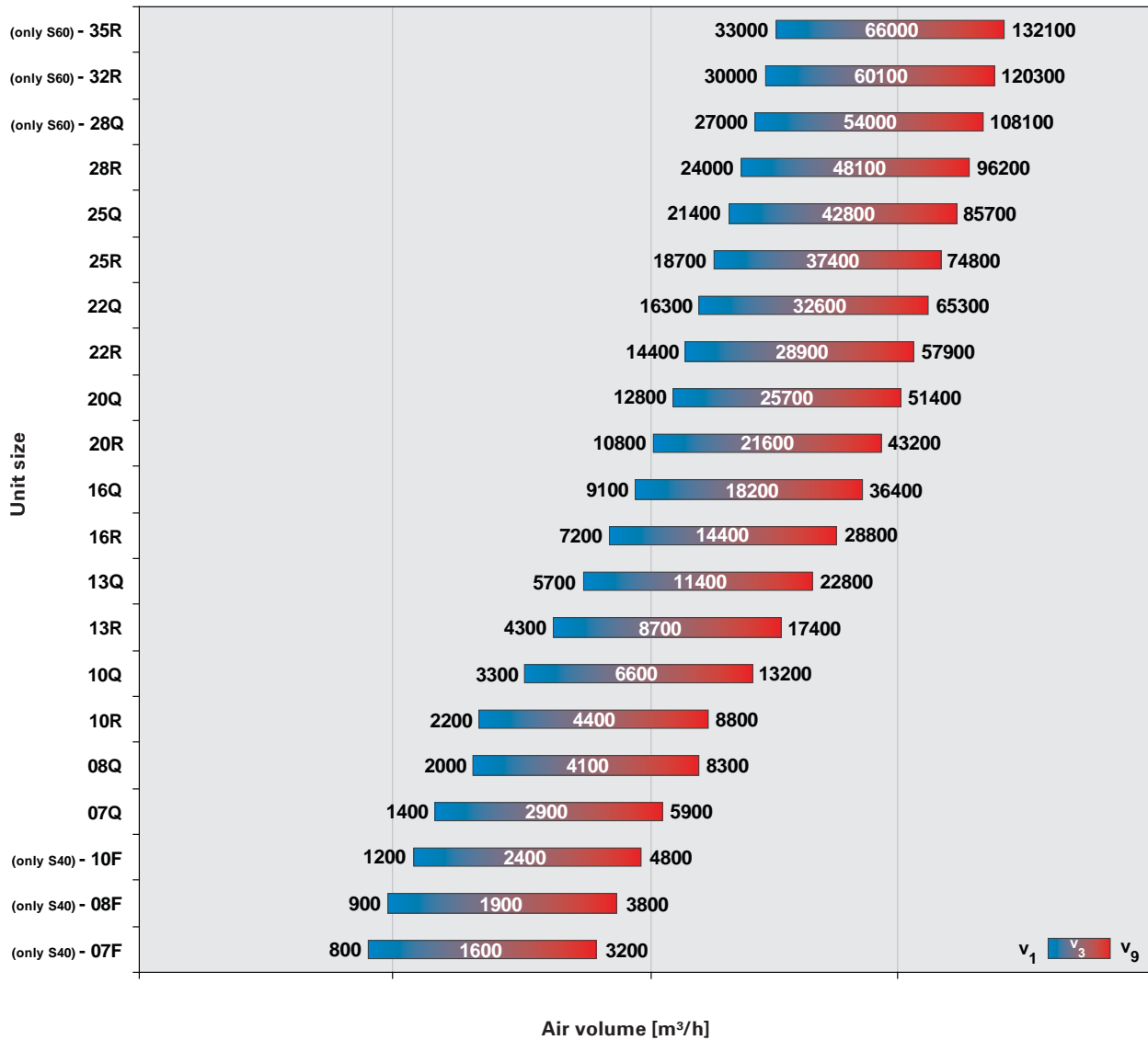

Air velocity: min. (v<sub>1</sub>) 1m/s ; optimal (v<sub>3</sub>) 2,0 m/s ; max. (v<sub>9</sub>) 4,0 m/s

ext. dimensions	Flat Unit			Standard AHU							
	S40-07F	S40-08F	S40-10F	S40-07Q	S40-08Q	S40-10R	S40-10Q	S40-13R	S40-13Q	S40-16R	S40-16Q
<b>B</b> [mm]	730	850	1050	730	850	1050	1050	1350	1350	1680	1680
<b>H</b> [mm]	440	440	440	730	850	730	1050	1050	1350	1350	1680

ext. dimensions	Standard AHU						
	S40-20R	S40-20Q	S40-22R	S40-22Q	S40-25R	S40-25Q	S40-28R
<b>B</b> [mm]	1980	1980	2220	2220	2530	2530	2830
<b>H</b> [mm]	1680	1980	1980	2220	2220	2530	2530

ext. dimensions	Standard AHU							
	S/T60-07Q	S/T60-08Q	S/T60-10R	S/T60-10Q	S/T60-13R	S/T60-13Q	S/T60-16R	S/T60-16Q
<b>B</b> [mm]	770	890	1090	1090	1390	1390	1720	1720
<b>H</b> [mm]	770	890	770	1090	1090	1390	1390	1720

ext. dimensions	Standard AHU									
	S/T60-20R	S/T60-20Q	S/T60-22R	S/T60-22Q	S/T60-25R	S/T60-25Q	S/T60-28R	S60-28Q	S60-32R	S60-35R
<b>B</b> [mm]	2020	2020	2260	2260	2570	2570	2870	2870	3180	3480
<b>H</b> [mm]	1720	2020	2020	2260	2260	2570	2570	2870	2870	2870



## Energy efficiency parameters of air handling units:

The main factors which, are important for the energy efficiency of an air handling unit, are the air velocity in the profile unit face, as well as the electric power consumption of the fan, which is dependent on the air volume and pressure increase. In a combined air handling unit with heat recovery (HRU), the efficiency and pressure loss of the heat recovery must also be taken into account. We work in accordance with the statutory requirements of the German Energy Saving Ordinance (EnEV), as well as the requirements of the German AHU Manufacturers Association (RLT), when selecting the parameters for air velocity, the electrical power consumption of the fans and the efficiency of heat recovery. The criteria of the RLT energy

efficiency label correspond to the standard DIN EN 13053 A1 (2011). This standard defines nine air velocity classes from V1 to V9, six heat recovery classes from H1 to H6, as well as six classes for the power consumption of fans, from P1 to P6. The specific power consumption of a fan (SFP), installed in the air handling unit, is calculated as defined by the current DIN EN 13779.

The accuracy of the data output by our AHU selection software is regularly checked and certified by TÜV Süd, on behalf of the RLT association.

For more information about the RLT energy efficiency label, refer to AHU-Guideline 01 from the German AHU Manufacturers Association (RLT). The AHU -Guideline 01 is available for free, as a pdf file on the association's website at [www.rlt-geraete.de](http://www.rlt-geraete.de).

Efficiency classes for AHU Guide-line 01			
Criteria	A+	A	B
<b>Velocity classes:</b>			
- without thermodynamic air treatment	V5	V6	V7
- with air heating and / or heat recovery	V4	V5	V6
- with other functions	V2	V3	V5
<b>Classes of power consumption of fan drives</b>	P2	P3	P4
<b>Heat recovery classes</b> (4000-6000 operation hour / year)	H1	H2	H3

Classes of air velocity levels according to EN 13053 A1 (2011)	
Class	Air velocity [m/s]
V1	maximal 1,6
V2	> 1,6 - 1,8
V3	> 1,8 - 2,0
V4	> 2,0 - 2,2
V5	> 2,2 - 2,5
V6	> 2,5 - 2,8
V7	> 2,8 - 3,2
V8	> 3,2 - 3,6
V9	> 3,6



## Eurovent energy efficiency label for the Rosenberg Airbox F40 and T60 unit series:

Specifically for the F40 and T60 series, the unit data sheet from our Eurovent-certified selection programm additionally specifies the Eurovent energy efficiency category, and we put this label on the unit.

In the same way as energy efficiency indications introduced for other areas in the EU, the Eurovent energy efficiency label divides air handling units into categories A to E. In this case, a general consideration is given to cha-



racteristic values for air velocities, external pressure losses, configuration outdoor temperature, pressure losses from the heat recovery , efficiency of the heat recovery and electric power consumption of the fans, in comparison to a single benchmark, and the unit is then assigned to the appropriate energy efficiency category.

For more information, refer to the official Eurovent website at [www.eurovent-certification.com](http://www.eurovent-certification.com).



**Type Code**

**AHU F - 40 16Q W Z**

**AHU** Air Handling Unit

**F** Casing type:  
 F = Frameless  
 A = Aluminiumprofil  
 S = Steel profile  
 E = Stainless steel profil  
 I = Thermally decoupled steel profile  
 K = Compact unit (40mm steel profile)

**40** Wall thickness:  
 20 = 20 mm  
 40 = 40 mm  
 60 = 60 mm

**16Q** Unit size (07F - 35R)

**W** Design:  
 I = Indoor installation (standard)  
 H = Hygienic design  
 W = outdoor installation

**Z** Unit type:  
 Z = Supply air unit  
 A = Exhaust air unit  
 K = Combined supply and exhaust air unit  
 W = Heat recovery unit  
 S = Special unit  
 X = Explosion-proof unit

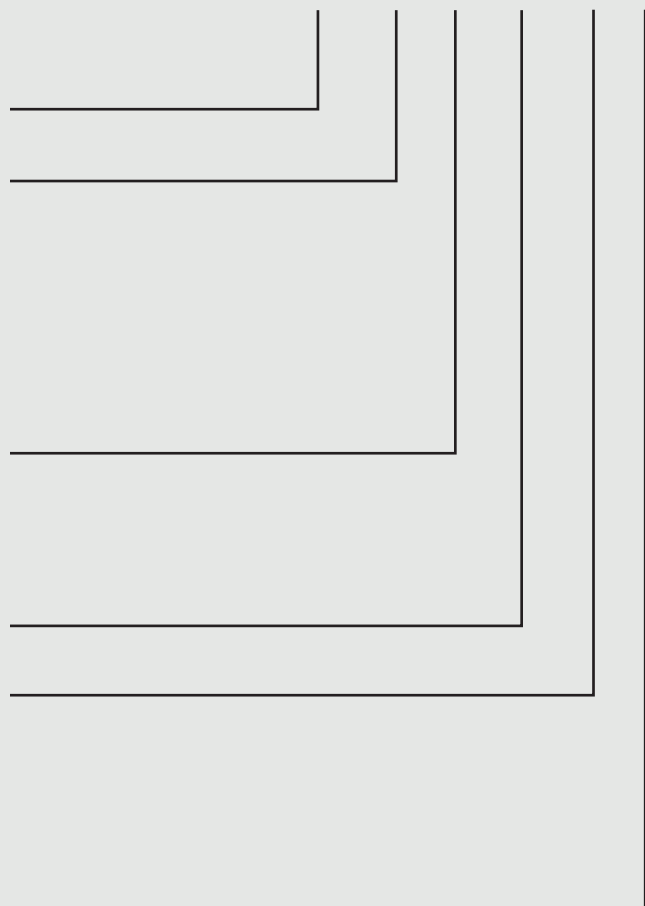



**Not available from January 2016!**

**Casing design:**

The units have a frame, made from hollow aluminium profile with two chambers, that are joined together using corner connectors, made from fibreglass reinforced polyamide. In order to ensure that the sidewalls are screwed together evenly, the profile is equipped with a guide groove. The 20 mm thick casing panels are double skinned. Up to size 08Q, the inside sheet is 0.75 mm thick, while the outside sheet is made from 1.0 mm galvanised steel. Coatings (standard RAL 7035) stainless steel (AISI 304), or aluminium panelling (AlMg3) are available on request. The glass wool mats inserted between the skins of the panels, are non-flammable and also have acou-

stic and thermal insulating properties. The panels are screwed onto the inside chamber of the frame profile. The two-chamber system reduces the thermal conductivity of the frame profile, with the effect, that condensation can be largely avoided here.

On request, base frames made from galvanised steel, with heights of 100 mm to 500 mm are available in steps of 100 mm.

**Mechanical and thermal performance (acc. to EN 1886, 2007):**

Thermal transmittance (coefficient of thermal transmittance U) [W/m²K]	Thermal bridging factor k <sub>b</sub> [-]	Filter bypass leakage	Casing leakage				
			Test pressure -400 Pa [dm³ x s⁻¹ x m²]	Test pressure +700 Pa [dm³ x s⁻¹ x m²]			
1,75 (T4)	0,39 (TB4)	F7 (1,6 %)	> L3 (3,0)	> L3 (4,8)			
Sheet thickness of outside sheet / inside sheet [mm]	Insulating material / density [kg/m³]	Casing stability [mm/m]	Weight of side panels [kg/m²]	Fire protection class of the insulation [-]			
1,0 / 0,75 & 1,0 / 1,25	glass wool / 27	D2 [6,2]	15 (from 08Q) & 18 (up to 10Q)	A2			
Octave band for casing sound insertion loss							
Frequency [Hz]	125	250	500	1000	2000	4000	8000
Sound insertion loss index [dB]	12	18	25	25	27	30	32

Airbox Type	Unit face [m <sup>2</sup> ]	Flow rate by air velocity [m <sup>3</sup> /h]			External dimensions		Internal dimensions	
		1,0 m/s	2,0 m/s	4,0 m/s	width [mm]	height [mm]	width [mm]	height [mm]
<b>A20-07F</b>	0,191	600	1300	2700	670	358	620	308
<b>A20-08F</b>	0,231	800	1600	3300	800	358	750	308
<b>A20-10F</b>	0,299	1000	2100	4300	1020	358	970	308
<b>A20-05Q</b>	0,203	700	1400	2900	500	500	450	450
<b>A20-07Q</b>	0,384	1300	2700	5500	670	670	620	620
<b>A20-08Q</b>	0,563	2000	4000	8100	800	800	750	750
<b>A20-10R</b>	0,601	2100	4300	8600	1020	670	970	620
<b>A20-10Q</b>	0,941	3300	6700	13500	1020	1020	970	970
<b>A20-13R</b>	1,183	4200	8500	17000	1270	1020	1220	970
<b>A20-13Q</b>	1,488	5300	10700	21400	1270	1270	1220	1220

### Panel connection

The panels for the Airbox A20 are screwed onto the aluminium frame profile, using countersunk tapped screws M6. The inside sheet of the panel is pressed against the frame profile by the outside sheet of the panel in this case. The necessary air leak tightness is achieved by the sealing strip between the inside sheet of the panel and the frame profile. Deformation of the outside sheet of the panel at the screw connection points means, that the countersunk screws form a level surface with the outside skin of the unit.

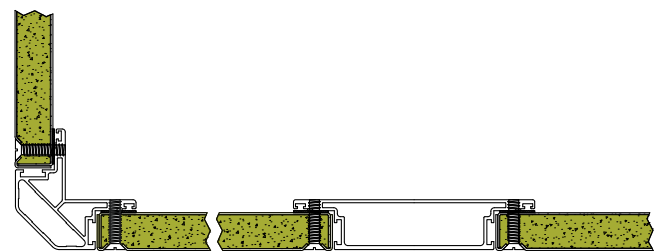

### Module connection:





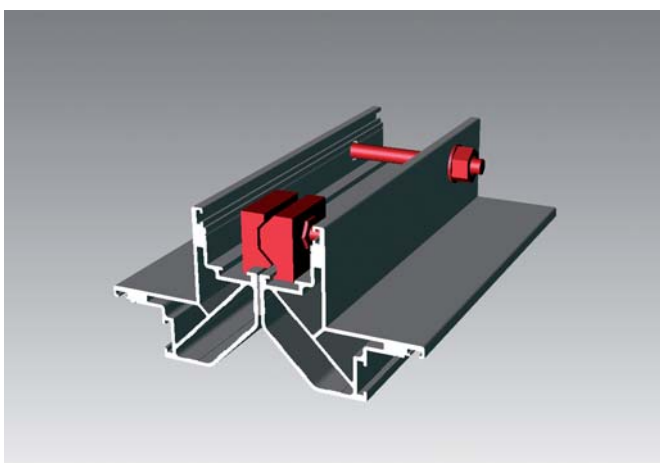





Special module connectors made from aluminium cast are used for connecting the modules. The number of connectors depends on the size. Sealing material is inserted between the modules. Generally speaking, each function of an air condition-

ing unit is fitted in a separate module. For reasons of space and cost, however, it is also possible to group together several components into one unit up to a length of 2.5 meter.

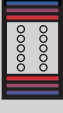

Size	Module connector (vertical connection)	Module connector (horizontal connection)
<b>07F - 08F</b>	-	4 pcs.
<b>10F</b>	-	6 pcs.
<b>05Q - 07Q</b>	2 pcs.	2 pcs.
<b>08Q - 10R</b>	4 pcs.	2 pcs.
<b>10Q ; 13R</b>	4 pcs.	2 pcs.
<b>13Q</b>	6 pcs.	4 pcs.

A20 - Module dimensions of the components [mm]												
Module	Symbol	dimens.	07F	08F	10F	05Q	07Q	08Q	10R	10Q	13R	13Q
Belt driven centrifugal fans		L	-	-	-	800	1020	1020	1020	1270	1270	1500
		B	-	-	-	500	670	800	1020	1020	1020	1270
		H	-	-	-	500	670	800	670	1020	1020	1270
Free running impeller with external rotor motor		L	500	500	500	500	670	670	670	800	800	800
		B	670	800	1020	500	670	800	1020	1020	1270	1270
		H	358	358	358	500	670	800	670	1020	1020	1270
Free running impeller with IEC standard motor		L	-	-	-	-	800	1020	800	1270	1270	1270
		B	-	-	-	-	670	800	1020	1020	1270	1270
		H	-	-	-	-	670	800	670	1020	1020	1270
Direct driven centrifugal fans		L	670	800	800	500	670	800	670	1020	1020	1270
		B	670	800	1020	500	670	800	1020	1020	1270	1270
		H	358	358	358	500	670	800	670	1020	1020	1270
Filter Z-line		L	220	220	220	220	220	220	-	-	-	-
		B	670	800	1020	500	670	800	-	-	-	-
		H	358	358	358	500	670	800	-	-	-	-
Bag filter M5 - F9 L = 600mm		L	800	800	800	-	800	800	800	800	800	800
		B	670	800	1020	-	670	800	1020	1020	1270	1270
		H	358	358	358	-	670	800	670	1020	1020	1270
Bag filter G4 L=360mm		L	500	500	500	-	500	500	500	500	500	500
		B	670	800	1020	-	670	800	1020	1020	1270	1270
		H	358	358	358	-	670	800	670	1020	1020	1270
Bag filter with drawable G4, M5 - F7 L = 350mm		L	500	500	500	500	500	500	-	-	-	-
		B	670	800	1020	500	670	800	-	-	-	-
		H	358	358	358	500	670	800	-	-	-	-
Panel filter G4, M5 - F9 L = 94mm		L	-	-	-	-	500	500	500	500	500	500
		B	-	-	-	-	670	800	1020	1020	1270	1270
		H	-	-	-	-	670	800	670	1020	1020	1270
Compact filter		L	670	670	670	-	670	670	670	670	670	670
		B	670	800	1020	-	670	800	1020	1020	1270	1270
		H	358	358	358	-	670	800	670	1020	1020	1270
Metal filter weaved		L	220	220	220	220	220	220	220	220	-	-
		B	670	800	1020	500	670	800	1020	1020	-	-
		H	358	358	358	500	670	800	670	1020	-	-
Carbon filter		L	670	670	670	670	670	670	800	800	800	800
		B	670	800	1020	500	670	800	1020	1020	1270	1270
		H	358	358	358	500	670	800	670	1020	1020	1270

A20 - Module dimensions of the components [mm]												
Module	Symbol	dimens.	07F	08F	10F	05Q	07Q	08Q	10R	10Q	13R	13Q
HEPA filter		L	-	-	-	800	800	800	800	800	800	800
		B	-	-	-	500	670	800	1020	1020	1270	1270
		H	-	-	-	500	670	800	670	1020	1020	1270
Heater 2 - 6 RR (KVS 6 RR)		L	358	358	358	358	358	358	358	358	358	358
		B	670	800	1020	500	670	800	1020	1020	1270	1270
		H	358	358	358	500	670	800	670	1020	1020	1270
Cooler 4 - 6 RR (KVS 6 RR)		L	500	500	500	500	500	500	500	500	500	500
		B	670	800	1020	500	670	800	1020	1020	1270	1270
		H	358	358	358	500	670	800	670	1020	1020	1270
Evaporator 4 - 6 RR		L	500	500	500	500	500	500	500	500	500	500
		B	670	800	1020	500	670	800	1020	1020	1270	1270
		H	358	358	358	500	670	800	670	1020	1020	1270
Electric heater		L	500	500	500	500	500	500	500	500	500	500
		B	670	800	1020	500	670	800	1020	1020	1270	1270
		H	358	358	358	500	670	800	670	1020	1020	1270
Sound attenuator: Typ 1, Typ 2, Typ 3, Typ 4, Typ 5		L1	800	800	800	800	800	800	800	800	800	800
		L2	1020	1020	1020	1020	1020	1020	1020	1020	1020	1020
		L3	1270	1270	1270	1270	1270	1270	1270	1270	1270	1270
		L4	1500	1500	1500	1500	1500	1500	1500	1500	1500	1500
		L5	1770	1770	1770	1770	1770	1770	1770	1770	1770	1770
Crossflow heat exchanger configuration ( one upon the other)		L	800	800	800	1020	1270	1270	1270	1600	2040	2340
		B	670	800	1020	500	670	800	1020	1020	1270	1270
		H	716	716	716	1000	1340	1600	1340	2040	2040	2540
Crossflow heat exchanger configuration ( side by side )		L	1270	1270	1270	1020	1270	1270	1600	1600	1600	2340
		B	1340	1600	2040	1000	1340	1600	2040	2040	2540	2540
		H	358	358	358	500	670	800	670	1020	1020	1270
Rotary heat exchanger L1 = without flow metering unit L2 = including flow metering unit		L1	-	-	-	-	670	670	670	670	670	670
		L2	-	-	-	-	1270	1270	1270	1500	1500	1500
		B	-	-	-	-	1020	1270	1270	1500	1600	1820
		H	-	-	-	-	1340	1600	1340	2040	2040	2540
Heat pipe L1 = 6 RR L2 = 8 RR including droplet eliminator		L1	-	-	-	670	670	670	670	670	670	670
		L2	-	-	-	800	800	800	800	800	800	800
		B	-	-	-	500	670	800	1020	1020	1270	1270
		H	-	-	-	1000	1340	1600	1340	2040	2040	2540
Mixing unit		L	670	670	670	500	500	500	500	500	670	670
		B	670	800	1020	500	670	800	1020	1020	1270	1270
		H	358	358	358	500	670	800	670	1020	1020	1270
Frost protection frame		L	220	220	220	220	220	220	220	220	220	220
		B										
		H										

Connection dimensions Airbox A20 flat units:

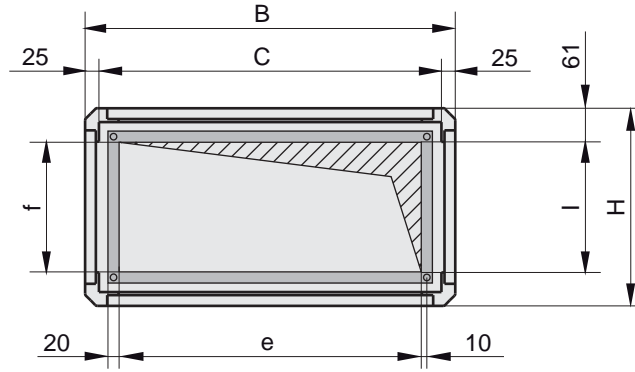

Size	B	C	H	l	e	f
A20-07F	670	620	358	236	547	235
A20-08F	800	750	358	236	677	235
A20-10F	1020	970	358	236	897	235

Connection dimensions Airbox A20 standard units (rectangular/quadratic):

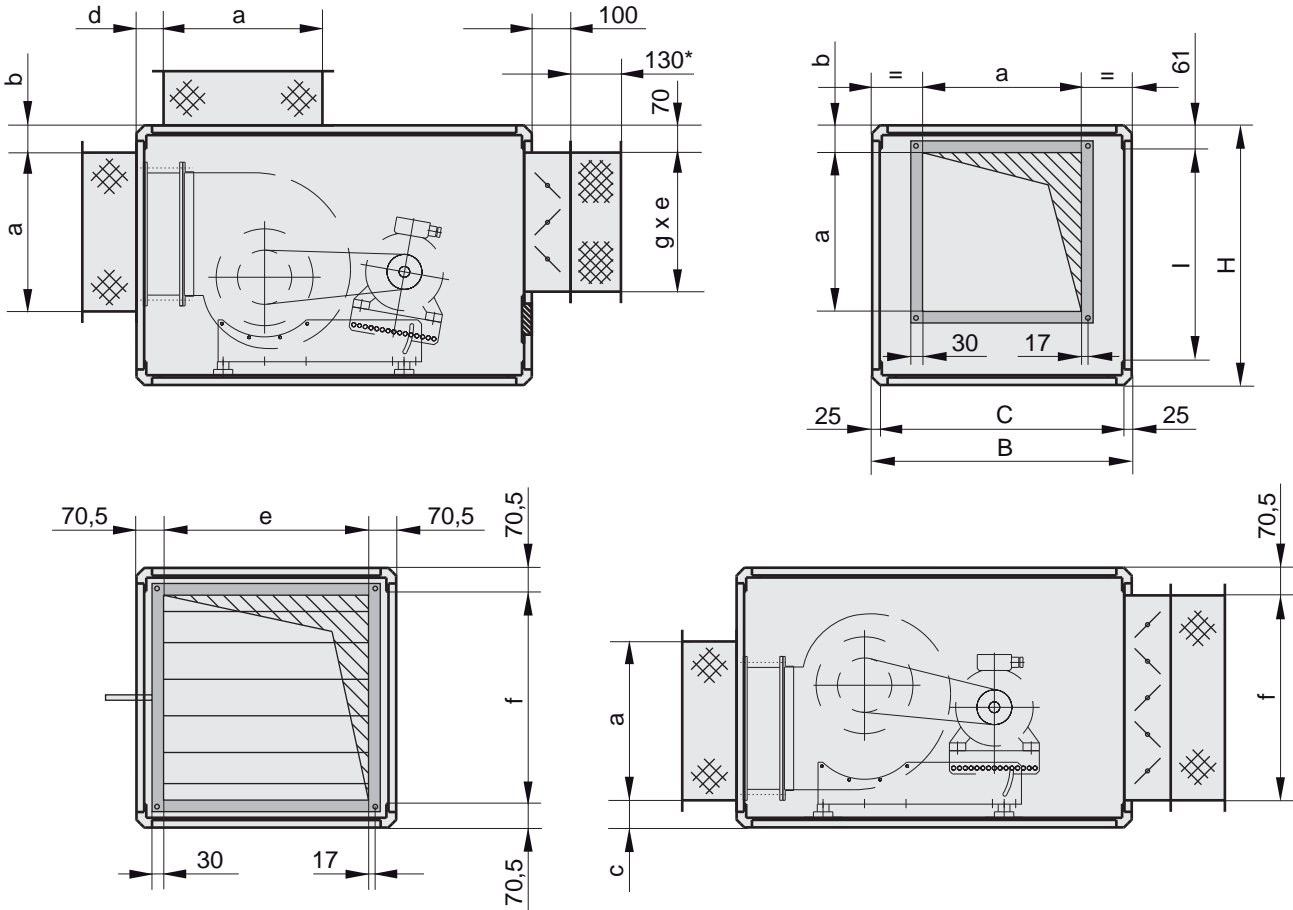

\* Installation length 130mm, total length 140mm / all dimensions in mm

Size	B	C	H	l	a	b	c	e	f	g
A20-05Q	500	450	500	378	359	70	70	359	359	-
A20-07Q	670	620	670	548	410	70	70	529	529	359
A20-08Q	800	750	800	678	500	80	80	659	659	359
A20-10R	1020	970	670	548	500	70	70	879	529	359
A20-10Q	1020	970	1020	898	659	100/90	90	879	879	359
A20-13R	1270	1220	1020	898	659	100	90	1129	879	529
A20-13Q	1270	1220	1270	1148	750	180/90	90	1129	1129	529



Reference object: Airport, Tiflis (Georgia)  
23 AHU's with air volumes from 5.000 - 25.000 m<sup>3</sup>/h





**Casing design:**

Units in the F40 series have a frameless construction. The Airbox F40 is a low-cost alternative to the S40 series, with small sizes up to a unit size 13Q (outside dimension 1340 x 1340 mm). All panels in the F40 series are double skinned, with an inside sheet, outside sheet and insulation in between. The insulation thickness of the side and top panels is 40 mm. The bottom panel of flat units with operation from underneath is also fitted with 40 mm thick insulation. In all other variants, the insulation thickness of the bottom panel is 60 mm. The inner surface of the unit is completely smooth. In the standard variant, galvanised steel sheet with a thickness of 1.0 mm, is used

for the panels. Alternatively, at additional cost, it is possible to select sheets in galvanised steel with plastic coating, stainless steel V2A (AISI 304) or aluminium AlMg3 separately for the outside and inside. The standard colour of the plastic coating is light grey RAL 7035. Other RAL colours are also possible. The rock wool, used as thermal and acoustic insulation, is non-flammable and is partly glued onto the double skin panel. F40 air handling units can be fitted with a folded base frame with heights from 100 mm to 500 mm, made from 3 mm thick galvanised steel sheet. The F40 units are Eurovent certified and suitable for meeting the hygiene regulations of VDI 6022.

**Mechanical and thermal performance (acc. to EN 1886, 2007):**

Thermal transmittance (coefficient of thermal transmittance U) [W/m²K]	Thermal bridging factor k <sub>b</sub> [-]	Filter bypass leakage		Casing leakage			
				Test pressure -400 Pa [dm³ x s <sup>-1</sup> x m <sup>-2</sup> ]	Test pressure +700 Pa [dm³ x s <sup>-1</sup> x m <sup>-2</sup> ]		
1,02 (T3)	0,58 (TB3)	F9 (0,32 %)		L2 (0,375)	L2 (0,512)		
Sheet thickness of outside sheet / inside sheet [mm]	Insulating material / density [kg/m³]	Casing stability [mm/m]	Weight of side panels [kg/m²]	Fire protection class of the insulation [-]			
1,0 / 1,0	rock wool / 33	D1 [3,8]	20	A1			
Octave band for casing sound insertion loss							
Frequency [Hz]	125	250	500	1000	2000	4000	8000
Sound insertion loss index [dB]	20	36	35	36	40	40	35

Airbox - F40								
Airbox Type	Unit face [m <sup>2</sup> ]	Flow rate by air velocity [m <sup>3</sup> /h]			External dimensions		Internal dimensions	
		1,0 m/s	2,0 m/s	4,0 m/s	width [mm]	height [mm]	width [mm]	height [mm]
F40-07F	0,224	800	1600	3200	720	450	640	350
F40-10F	0,336	1200	2400	4800	1040	450	960	350
F40-07Q	0,397	1400	2800	5700	720	720	640	620
F40-10R	0,595	2100	4200	8500	1040	720	960	620
F40-10Q	0,902	3200	6400	12900	1040	1040	960	940
F40-13R	1,184	4200	8500	17000	1340	1040	1260	940
F40-13Q	1,562	5600	11200	22400	1340	1340	1260	1240

### Panel connection:

The panels of the F40 series are designed to be offset in relation to one another at their connection points. They are screwed on from the outside at opposite sides in each case along the outside edges, meaning that a highly stable connection is achieved. The screws are located completely within the panel in order to provide the best possible thermal and visual properties. The openings in the outside sheet required for the screw connection on the inside are tightly sealed with UV-resistant plastic caps.

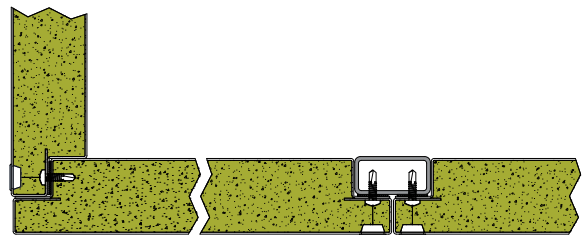







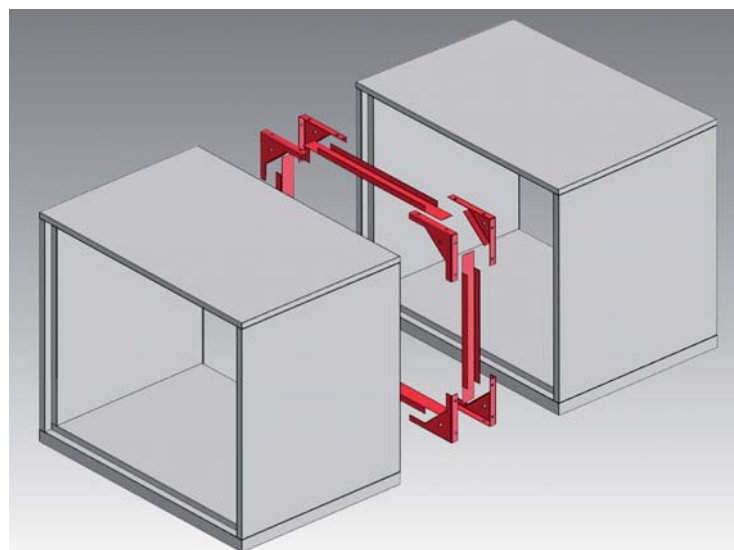



### Module connection:

Gusset plates are mounted on the casing corners at the factory in order to connect the modules. The supplied tapped screws tighten the modules to the opposite gusset plates. The U-profiles, that are supplied produce a completely smooth

module joint. The screw connections of the module joint are covered with plastic caps in order to achieve a high hygiene quality.

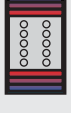

F40 - Module dimensions of the components [mm]									
Module	Symbol	dimens.	07F	10F	07Q	10R	10Q	13R	13Q
Belt driven centrifugal fans		L	800	800	1000	1000	1200	1200	1400
		B	720	1040	720	1040	1040	1340	1340
		H	450 / 430	450 / 430	720	720	1040	1040	1340
Free running impeller with external rotor motor (AC- / EC-Technic)		L	600	600	600	600	800	1000	1000
		B	720	1040	720	1040	1040	1340	1340
		H	450 / 430	450 / 430	720	720	1040	1040	1340
Free running impeller with IEC standard motor		L	-	-	800	800	900	900	1100
		B	720	1040	720	1040	1040	1340	1340
		H	450 / 430	450 / 430	720	720	1040	1040	1340
Direct driven centrifugal fans		L	700	700	800	800	1000	1000	1100
		B	720	1040	720	1040	1040	1340	1340
		H	450 / 430	450 / 430	720	720	1040	1040	1340
Filter Z-line		L	300	300	300	300	300	-	-
		B	720	1040	720	1040	1040	1340	1340
		H	450 / 430	450 / 430	720	720	1040	1040	1340
Bag filter <sup>3)</sup> M5 - F9 L = 600mm		L	800	800	800	800	800	800	800
		B	720	1040	720	1040	1040	1340	1340
		H	450 / 430	450 / 430	720	720	1040	1040	1340
Bag filter <sup>3)</sup> G4 L=360mm		L	500	500	500	500	500	500	500
		B	720	1040	720	1040	1040	1340	1340
		H	450 / 430	450 / 430	720	720	1040	1040	1340
Panel filter		L	400	400	400	400	400	400	400
		B	720	1040	720	1040	1040	1340	1340
		H	450 / 430	450 / 430	720	720	1040	1040	1340
Compact filter		L	500	500	500	500	500	500	500
		B	720	1040	720	1040	1040	1340	1340
		H	450 / 430	450 / 430	720	720	1040	1040	1340
Metal filter weaved		L	300	300	300	300	300	300	300
		B	720	1040	720	1040	1040	1340	1340
		H	450 / 430	450 / 430	720	720	1040	1040	1340
Carbon filter		L	700	700	700	700	700	700	700
		B	720	1040	720	1040	1040	1340	1340
		H	450 / 430	450 / 430	720	720	1040	1040	1340
HEPA filter		L	700	700	700	700	700	700	700
		B	720	1040	720	1040	1040	1340	1340
		H	450 / 430	450 / 430	720	720	1040	1040	1340

F40 - Module dimensions of the components [mm]									
Module	Symbol	dimens.	07F	10F	07Q	10R	10Q	13R	13Q
<b>Heater</b> L1 = 1 - 6 RR L2 = 8 RR		L1	300	300	300	300	300	300	300
		L2	400	400	400	400	400	400	400
		B	720	1040	720	1040	1040	1340	1340
		H	450 / 430	450 / 430	720	720	1040	1040	1340
<b>Cooler</b> L1 = 1 - 3 RR L2 = 4 - 6 RR L3 = 8 RR		L1	500	500	500	500	500	500	500
		L2	600	600	600	600	600	600	600
		L3	700	700	700	700	700	700	700
		B	720	1040	720	1040	1040	1340	1340
		H	450 / 430	450 / 430	720	720	1040	1040	1340
<b>Evaporator</b> L1 = 1 - 3 RR L2 = 4 - 6 RR L3 = 8 RR		L1	500	500	500	500	500	500	500
		L2	600	600	600	600	600	600	600
		L3	700	700	700	700	700	700	700
		B	720	1040	720	1040	1040	1340	1340
		H	450 / 430	450 / 430	720	720	1040	1040	1340
<b>Electric heater</b>		L	400	400	400	400	400	400	400
		B	720	1040	720	1040	1040	1340	1340
		H	450 / 430	450 / 430	720	720	1040	1040	1340
<b>Sound attenuator:</b> Typ 1, Typ 2, Typ 3, Typ 4, Typ 5		L1	1000	1000	1000	1000	1000	1000	1000
		L2	1300	1300	1300	1300	1300	1300	1300
		L3	1500	1500	1500	1500	1500	1500	1500
		L4	1800	1800	1800	1800	1800	1800	1800
		L5	2000	2000	2000	2000	2000	2000	2000
<b>Crossflow heat exchanger configuration <sup>1)</sup></b>		L	900	900	1100	1300	1700	1900	2400
		B	720	1040	720	1040	1040	1340	1340
		H	900	900	1440	1440	2080	2080	2680
<b>Crossflow heat exchanger configuration <sup>2)</sup></b>		L	1400	1900	1300	1700	1700	1900	2400
		B	1440	2080	1440	2080	2080	2680	2680
		H	450 / 430	450 / 430	720	720	1040	1040	1340
<b>Rotary heat exchanger</b> L1 = without flow metering unit L2 = including flow metering unit		L1	-	-	800	800	800	800	800
		L2	-	-	1500	1500	1500	1500	1500
		B	-	-	720	1040	1040	1340	1340
		H	-	-	1440	2080	2080	2680	2680
<b>Heat pipe</b> 4 - 8 RR including droplet eliminator		L	-	-	800	800	800	800	800
		B	-	-	720	1040	1040	1340	1340
		H	-	-	1440	2080	2080	2680	2680
<b>Mixing unit</b>		L	500	500	500	500	500	800	800
		B	720	1040	720	1040	1040	1340	1340
		H	450 / 430	450 / 430	720	720	1040	1040	1340
<b>Frost protection frame</b>		L	300	300	300	300	300	300	300
		B	720	1040	720	1040	1040	1340	1340
		H	450 / 430	450 / 430	720	720	1040	1040	1340

1) Dimensions arrangement one upon the other

2) Dimensions arrangement side by side

3) for filter service on dusty air side (VDI 6022) an additional service module is necessary. Alternatively Rosenberg terminal strip system is possible.

Connection dimensions Airbox F40 flat units:

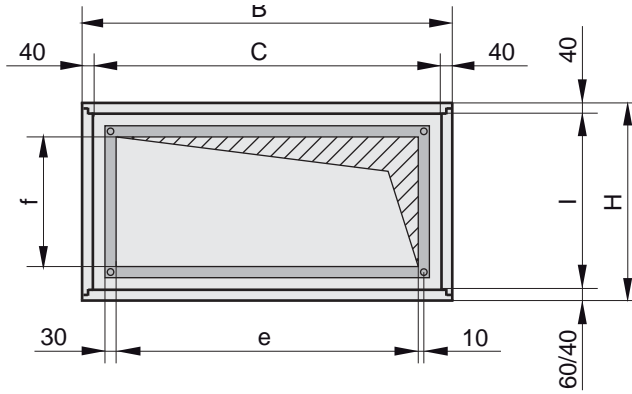

Size	B	C	H	I	e	f
F40-07F	720	640	430/450	350	620	330
F40-10F	1040	960	430/450	350	940	330

Connection dimensions Airbox F40 standard units (rectangular/quadratic):

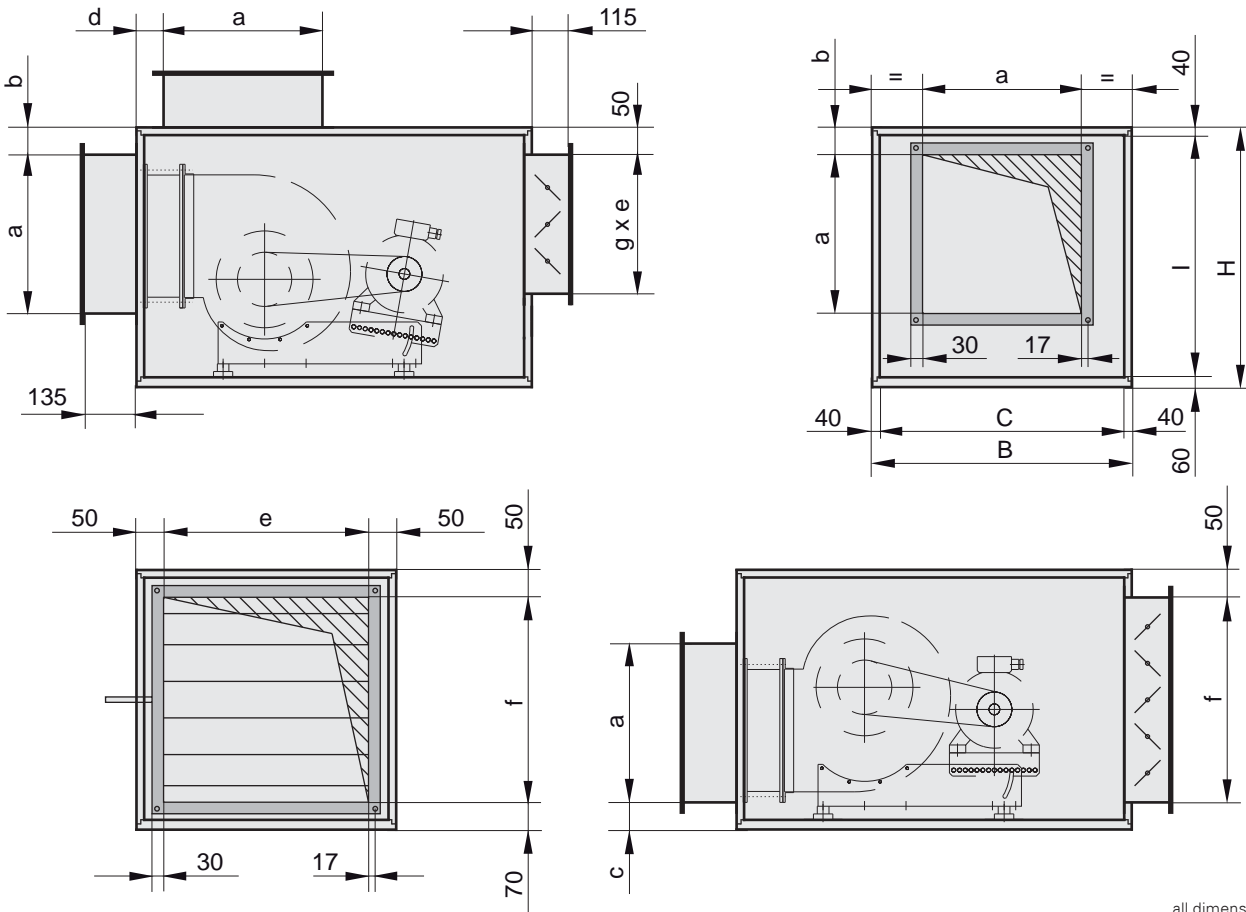

all dimensions in mm

Size	B	C	H	I	a	b	c	d	e	f	g
F40-07Q	720	640	720	620	410	70	90	70	620	600	340
F40-10R	1040	960	720	620	500	70	90	70	940	600	340
F40-10Q	1040	960	1040	940	580	200/100	100/170	70	940	920	560
F40-13R	1340	1260	1040	940	700	100	100	100	1240	920	560
F40-13Q	1340	1260	1340	1240	700	215/270	170	100	1240	1220	660



Reference object: Deutsche Gelatine, Heilbronn (Germany)  
7 AHU's with air volumes from 20.000 - 50.000 m<sup>3</sup>/h



**Casing design:**

S40 units have a frame made from rolled, galvanised steel profiles and corner connectors made from aluminium die cast components or fibreglass-reinforced plastic. The aluminium die-cast corner connectors can be supplied with or without M20 threads in order to attach crane lugs, for example. Frame profiles and aluminium die-cast connectors are sealed against one another by EPDM seals. The panels of the casing are a double-skin construction with a 40 mm wall thickness. In the basic version, 1.0 mm thick galvanised steel sheet is used for the inside and outside sheets. Alternatively, the S40 casings are available with plastic coating (standard RAL 7035), in V2A

AISI 304 or with aluminium panelling AlMg3. The rock wool used as thermal and acoustic insulation is non-flammable and is partly glued onto the double skin panel. The panels are screwed on to the hollow frame profile from the outside. The connections between the casing components are configured so the insides are smooth. The units up size 13Q can be provided with a folded base frame made from 3 mm thick galvanised steel sheet. Alternatively, welded steel base frames in a galvanised or painted design are available for larger sizes. S40 units are suitable for meeting the hygiene regulations of VDI 6022 and DIN 1946 T4.

**Mechanical and thermal performance (acc. to EN 1886, 2007):**

Thermal transmittance (coefficient of thermal transmittance U) [W/m²K]	Thermal bridging factor k <sub>b</sub> [-]	Filter bypass leakage	Casing leakage	
			Test pressure -400 Pa [dm³ x s⁻¹ x m⁻²]	Test pressure +700 Pa [dm³ x s⁻¹ x m⁻²]
1,2 (T3)	0,54 (TB3)	F9 (0,09 %)	L1 (M) [0,150]	L1 (M) [0,170]

Sheet thickness of outside sheet / inside sheet [mm]	Insulating material / density [kg/m³]	Casing stability [mm/m]	Weight of side panels [kg/m²]	Fire protection class of the insulation [-]
1,0 / 1,0 (reinforced 1,25 / 1,25)	rock wool / 40-90	D1 (M) [2,2]	20	A1

Octave band for casing sound insertion loss							
Frequency [Hz]	125	250	500	1000	2000	4000	8000
Sound insertion loss index [dB] (R)	18	23	32	33	34	35	34

Airbox - S40								
Airbox Type	Unit face [m <sup>2</sup> ]	Flow rate by air velocity [m <sup>3</sup> /h]			External dimensions		Internal dimensions	
		1,0 m/s	2,0 m/s	4,0 m/s	width [mm]	height [mm]	width [mm]	height [mm]
<b>S40-07F</b>	0,224	800	1600	3200	730	440	640	350
<b>S40-08F</b>	0,266	900	1900	3800	850	440	760	350
<b>S40-10F</b>	0,336	1200	2400	4800	1050	440	960	350
<b>S40-07Q</b>	0,410	1400	2900	5900	730	730	640	640
<b>S40-08Q</b>	0,578	2000	4100	8300	850	850	760	760
<b>S40-10R</b>	0,614	2200	4400	8800	1050	730	960	640
<b>S40-10Q</b>	0,922	3300	6600	13200	1050	1050	960	960
<b>S40-13R</b>	1,210	4300	8700	17400	1350	1050	1260	960
<b>S40-13Q</b>	1,588	5700	11400	22800	1350	1350	1260	1260
<b>S40-16R</b>	2,003	7200	14400	28800	1680	1350	1590	1260
<b>S40-16Q</b>	2,528	9100	18200	36400	1680	1680	1590	1590
<b>S40-20R</b>	3,005	10800	21600	43200	1980	1680	1890	1590
<b>S40-20Q</b>	3,572	12800	25700	51400	1980	1980	1890	1890
<b>S40-22R</b>	4,026	14400	28900	57900	2220	1980	2130	1890
<b>S40-22Q</b>	4,537	16300	32600	65300	2220	2220	2130	2130
<b>S40-25R</b>	5,197	18700	37400	74800	2530	2220	2440	2130
<b>S40-25Q</b>	5,954	21400	42800	85700	2530	2530	2440	2440
<b>S40-28R</b>	6,686	24000	48100	96200	2830	2530	2740	2440

**Panel connection:**

The panels are screwed onto the connecting profile from outside. In order to provide a good visual look, the screws on the outsides of the casing are concealed. A sealing strip is glued between the panels and profile.

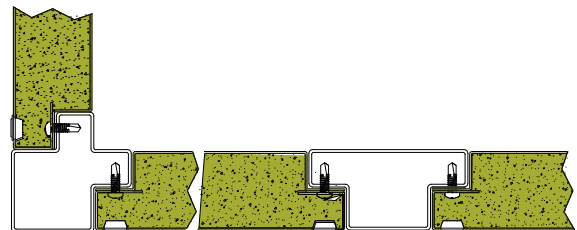
**Module connection:**

The modules are connected in different ways depending on their size. The supplied self-adhesive sealing tape (40 mm x 3 mm) must be affixed to one of the two modules which are to be connected. Folded gusset plates are installed in the cor-

ners at the factory. The modules are tightened onto these with supplied screws M8 x 110 mm. In modules from unit size 13R upwards, it is necessary to set additional module connectors along the edges of the unit face.

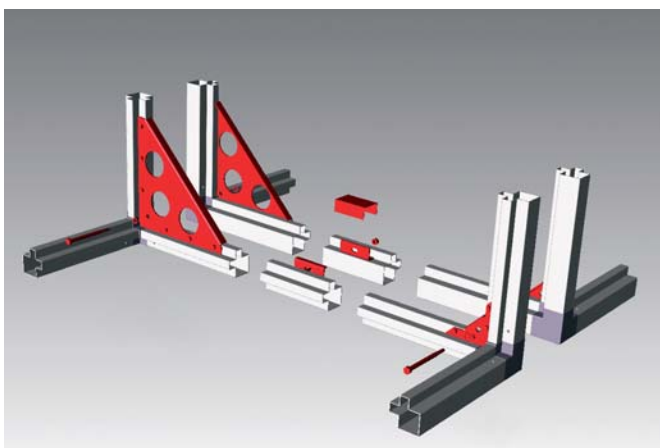













Size	Folded gusset plate	Module connector (vertical connection)	Module connector (horizontal connection)
<b>07Q - 10Q</b>	4 pcs. (small corners)	-	-
<b>13R</b>	4 pcs. (small corners)	-	1 pcs.
<b>13Q - 16Q</b>	4 pcs (small corners)	1 pcs.	1 pcs.
<b>20R</b>	4 pcs. (large corners)	1 pcs.	2 pcs.
<b>20Q - 28R</b>	4 pcs. (large corners)	2 pcs.	2 pcs.













S40 - Module dimensions of the components [mm]											
Module	Symbol	dimens.	07F	08F	10F	07Q	08Q	10R	10Q	13R	13Q
Belt driven centrifugal fans		L	810	810	810	1050	1050	1050	1290	1530	1530
		B	730	850	1050	730	850	1050	1050	1350	1350
		H	440	440	440	730	850	730	1050	1050	1350
Free running impeller with external rotor motor (AC- / EC-Technic)		L	570	570	810	810	810	810	810	1050	1050
		B	730	850	1050	730	850	1050	1050	1350	1350
		H	440	440	440	730	850	730	1050	1050	1350
Free running impeller with IEC standard motor		L	-	-	-	810	1050	810	1290	1290	1290
		B	-	-	-	730	850	1050	1050	1350	1350
		H	-	-	-	730	850	730	1050	1050	1350
Direct driven centrifugal fans		L	810	810	810	810	810	810	1050	1050	1290
		B	730	850	1050	730	850	1050	1050	1350	1350
		H	440	440	440	730	850	850	1050	1050	1350
Filter Z-line		L	330	330	330	330	330	330	330	-	-
		B	730	850	1050	730	850	1050	1050	-	-
		H	440	440	440	730	850	730	1050	-	-
Bag filter <sup>3)</sup> M5 - F9 L = 600mm		L	810	810	810	810	810	810	810	810	810
		B	730	850	1050	730	850	1050	1050	1350	1350
		H	440	440	440	730	850	730	1050	1050	1350
Bag filter <sup>3)</sup> G4 L=360mm		L	570	570	570	570	570	570	570	570	570
		B	730	850	1050	730	850	850	1050	1350	1350
		H	440	440	440	730	850	850	1050	1050	1350
Panel filter G4, M5 - F9 L = 94mm		L	570	570	570	570	570	570	570	570	570
		B	730	850	1050	730	850	850	1050	1350	1350
		H	440	440	440	730	850	850	1050	1050	1350
Compact filter		L	570	570	570	570	570	570	570	570	570
		B	730	850	1050	730	850	850	1050	1350	1350
		H	440	440	440	730	850	850	1050	1050	1350
Metal filter weaved		L	330	330	330	330	330	330	330	570	570
		B	730	850	1050	730	850	1050	1050	1350	1350
		H	440	440	440	730	850	730	1050	1050	1350
Carbon filter		L	810	810	810	810	810	810	810	810	810
		B	730	850	1050	730	850	1050	1050	1350	1350
		H	440	440	440	730	850	730	1050	1050	1350
HEPA filter		L	-	-	-	810	810	810	810	810	810
		B	-	-	-	730	850	1050	1050	1350	1350
		H	-	-	-	730	850	730	1050	1050	1350

**S40 - Module dimensions of the components [mm]**

Module	Symbol	dimens.	16R	16Q	20R	20Q	22R	22Q	25R	25Q	28R
<b>Belt driven centrifugal fans</b>		L	1770	2010	2250	2445	2445	2685	2925	2925	2925
		B	1680	1680	1980	1980	2220	2220	2530	2530	2830
		H	1350	1680	1680	1980	1980	2220	2220	2530	2530
<b>Free running impeller with external rotor motor (AC- / EC-Technic)</b>		L	1170	1170	-	-	-	-	-	-	-
		B	1680	1680	-	-	-	-	-	-	-
		H	1350	1680	-	-	-	-	-	-	-
<b>Free running impeller with IEC standard motor</b>		L	1290	1530	1530	1725	1725	1725	1725	1725	1725
		B	1680	1680	1980	1980	2220	2220	2530	2530	2830
		H	1350	1680	1680	1980	1980	2220	2220	2530	2530
<b>Direct driven centrifugal fans</b>		L	1290	1290	-	-	-	-	-	-	-
		B	1680	1680	-	-	-	-	-	-	-
		H	1350	1680	-	-	-	-	-	-	-
<b>Filter Z-line</b>		L	-	-	-	-	-	-	-	-	-
		B	-	-	-	-	-	-	-	-	-
		H	-	-	-	-	-	-	-	-	-
<b>Bag filter<sup>3)</sup> M5 - F9 L = 600mm</b>		L	810	810	810	765	765	765	765	765	765
		B	1680	1680	1980	1980	2220	2220	2530	2530	2830
		H	1350	1680	1680	1980	1980	2220	2220	2530	2530
<b>Bag filter<sup>3)</sup> G4 L=360mm</b>		L	570	570	570	525	525	525	525	525	525
		B	1680	1680	1980	1980	2220	2220	2530	2530	2830
		H	1350	1680	1680	1980	1980	2220	2220	2530	2530
<b>Panel filter G4, M5 - F9 L = 94mm</b>		L	570	570	570	525	525	525	525	525	525
		B	1680	1680	1980	1980	2220	2220	2530	2530	2830
		H	1350	1680	1680	1980	1980	2220	2220	2530	2530
<b>Compact filter</b>		L	570	570	570	765	765	765	765	765	765
		B	1680	1680	1980	1980	2220	2220	2530	2530	2830
		H	1350	1680	1680	1980	1980	2220	2220	2530	2530
<b>Metal filter weaved</b>		L	-	-	-	-	-	-	-	-	-
		B	-	-	-	-	-	-	-	-	-
		H	-	-	-	-	-	-	-	-	-
<b>Carbon filter</b>		L	810	810	810	765	-	-	-	-	-
		B	1680	1680	1980	1980	-	-	-	-	-
		H	1350	1680	1680	1980	-	-	-	-	-
<b>HEPA filter</b>		L	810	810	810	765	-	-	-	-	-
		B	1680	1680	1980	1980	-	-	-	-	-
		H	1350	1680	1680	1980	-	-	-	-	-

S40 - Module dimensions of the components [mm]												
Module	Symbol	dimens.	07F	08F	10F	07Q	08Q	10R	10Q	13R	13Q	
<b>Heater</b> L1 = 1 - 3 RR L2 = 4 - 6 RR L3 = 8 RR		L1	330	330	330	330	330	330	330	330	330	
		L2	330	330	330	330	330	330	330	330	330	
		L3	570	570	570	570	570	570	570	570	570	
		B	730	850	1050	730	850	1050	1050	1050	1350	1350
		H	440	440	440	730	850	730	1050	1050	1050	1350
<b>Cooler</b> L1 = 1 - 3 RR L2 = 4 - 6 RR L3 = 8 RR		L1	570	570	570	570	570	570	570	570	570	
		L2	570	570	570	570	570	570	570	570	570	
		L3	810	810	810	810	810	810	810	810	810	
		B	730	850	1050	730	850	1050	1050	1050	1350	1350
		H	440	440	440	730	850	730	1050	1050	1050	1050
<b>Evaporator</b> L1 = 1 - 3 RR L2 = 4 - 6 RR L3 = 8 RR		L1	570	570	570	570	570	570	570	570	570	
		L2	570	570	570	570	570	570	570	570	570	
		L3	810	810	810	810	810	810	810	810	810	
		B	730	850	1050	730	850	1050	1050	1050	1350	1350
		H	440	440	440	730	850	730	1050	1050	1050	1050
<b>Electric heater</b>		L	570	570	570	570	570	570	570	570	570	
		B	730	850	1050	730	850	850	1050	1350	1350	
		H	440	440	440	730	850	850	1050	1050	1350	
<b>Sound attenuator:</b> Typ 1, Typ 2, Typ 3, Typ 4, Typ 5		L1	1050	1050	1050	1050	1050	1050	1050	1050	1050	
		L2	1290	1290	1290	1290	1290	1290	1290	1290	1290	
		L3	1530	1530	1530	1530	1530	1530	1530	1530	1530	
		L4	1770	1770	1770	1770	1770	1770	1770	1770	1770	
		L5	2010	2010	2010	2010	2010	2010	2010	2010	2010	
<b>Crossflow heat exchanger configuration <sup>1)</sup></b>		L	1050	1050	1050	1290	1290	1290	1650	1890	2370	
		B	730	850	1050	730	850	1050	1050	1350	1350	
		H	880	880	880	1460	1700	1460	2100	2100	2700	
<b>Crossflow heat exchanger configuration <sup>2)</sup></b>		L	1050	1050	1050	1290	1290	1290	1650	1890	2370	
		B	1460	1700	2100	1460	1700	2100	2100	2700	2700	
		H	440	440	440	730	850	730	1050	1050	1350	
<b>Rotary heat exchanger <sup>1)</sup></b> L1 = without flow metering unit L2 = including flow metering unit		L1	570	570	570	570	570	570	570	570	570	
		L2	-	-	-	1530	1530	1530	1530	1530	1530	
		B	730	850	1290	1290	1530	1530	1980	2010	2490	
		H	880	880	880	1460	1700	1460	2100	2100	2700	
<b>Heat pipe<sup>1)</sup></b> 4 - 8 RR including droplet eliminator		L	-	-	-	810	810	810	810	810	810	
		B	-	-	-	730	850	1050	1050	1350	1350	
		H	-	-	-	1460	1700	1460	2100	2100	2700	
<b>Mixing unit</b>		L	570	570	570	570	570	570	570	810	810	
		B	730	850	1050	730	850	1050	1050	1350	1350	
		H	440	440	440	730	850	730	1050	1050	1350	
<b>Frost protection frame</b>		L	330	330	330	330	330	330	330	330	330	
		B	730	850	1050	730	850	1050	1050	1350	1350	
		H	440	440	440	730	850	730	1050	1050	1350	

S40 - Module dimensions of the components [mm]												
Module	Symbol	dimens.	16R	16Q	20R	20Q	22R	22Q	25R	25Q	28R	
<b>Heater</b> L1 = 1 - 3 RR L2 = 4 - 6 RR L3 = 8 RR		L1	330	330	330	525	525	525	525	525	525	
		L2	330	330	330	525	525	525	525	525	525	
		L3	570	570	570	525	-	-	-	-	-	-
		B	1680	1680	1980	1980	2220	2220	2530	2530	2830	2830
		H	1350	1680	1680	1980	1980	2220	2220	2530	2530	
<b>Cooler</b> L1 = 1 - 3 RR L2 = 4 - 6 RR L3 = 8 RR		L1	570	810	1050	1005	1005	1005	1005	1005	1005	
		L2	810	1050	1050	1005	1005	1005	1005	1005	1005	
		L3	810	1050	1050	1005	1005	1005	1005	1005	1005	
		B	1680	1680	1980	1980	2220	2220	2530	2530	2830	2830
		H	1350	1680	1680	1980	1980	2220	2220	2530	2530	
<b>Evaporator</b> L1 = 1 - 3 RR L2 = 4 - 6 RR L3 = 8 RR		L1	570	810	1050	1005	1005	1005	1005	1005	1005	
		L2	810	1050	1050	1005	1005	1005	1005	1005	1005	
		L3	810	1050	1050	1005	1005	1005	1005	1005	1005	
		B	1680	1680	1980	1980	2220	2220	2530	2530	2830	2830
		H	1350	1680	1680	1980	1980	2220	2220	2530	2530	
<b>Electric heater</b>		L	-	-	-	-	-	-	-	-	-	
		B	-	-	-	-	-	-	-	-	-	
		H	-	-	-	-	-	-	-	-	-	
<b>Sound attenuator:</b> Typ 1, Typ 2, Typ 3 Typ 4, Typ 5		L1	1050	1050	1050	1245	1245	1245	1245	1245	1245	
		L2	1290	1290	1290	1485	1485	1485	1485	1485	1485	
		L3	1530	1530	1530	1725	1725	1725	1725	1725	1725	
		L4	1770	1770	1770	1965	1965	1965	1965	1965	1965	
		L5	2010	2010	2010	2205	2205	2205	2205	2205	2205	
<b>Crossflow heat exchanger configuration <sup>1)</sup></b>		L	2490	3255	3255	3210	3210	3690*	3690*	3690*	3690*	
		B	1680	1680	1980	1980	2220	2220*	2530*	2530*	2830*	
		H	2700	3360	3360	3960	3960	4440*	4440*	5060*	5060*	
<b>Crossflow heat exchanger configuration <sup>2)</sup></b>		L	2490	3255	3255	3210	3210	3690*	3690*	3690*	3690*	
		B	3360	3360	3960	3960	4440	4440*	5060*	5060*	5660*	
		H	1350	1680	1680	1980	1980	2220*	2220*	2530*	2530*	
<b>Rotary heat exchanger <sup>1)</sup></b> L1 = without flow metering unit L2 = including flow metering unit		L1	570	570	570	570	570	570	570	570	570	
		L2	1530	1530	1530	1965	1965	1965	1965	1965	1965	
		B	2010	2490	2490	2730	2970	3210	3450	3690	3690	
		H	2700	3360	3360	3960	3960	4440	4440	5060	5060	
<b>Heat pipe <sup>1)</sup></b> 4 - 8 RR including droplet eliminator		L	810	1050	1050	1050	1005	-	-	-	-	
		B	1680	1680	1980	1980	2220	-	-	-	-	
		H	2700	3360	3360	3960	3960	-	-	-	-	
<b>Mixing unit</b>		L	810	810	1050	1050	1005	1005	1245	1245	1245	
		B	1680	1680	1980	1980	2220	2220	2530	2560	2830	
		H	1350	1680	1680	1980	1980	2220	2220	2530	2530	
<b>Frost protection frame</b>		L	330	330	330	285	330	-	-	-	-	
		B	1680	1680	1980	1980	2220	-	-	-	-	
		H	1350	1680	1680	1980	1980	-	-	-	-	

1) Dimensions arrangement one upon the other

2) Dimensions arrangement side by side

3) for filter service on dusty air side (VDI 6022) an additional service module is necessary. Alternatively Rosenberg terminal strip system is possible.

## Connection dimensions Airbox S40 flat units:

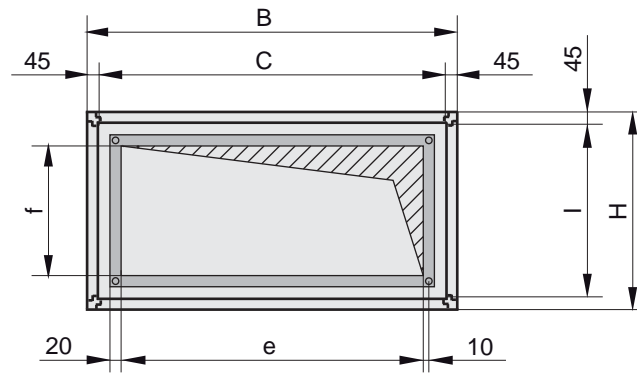

all dimensions in mm

Size	B	C	H	I	e	f
<b>S40-07F</b>	730	640	440	310	600	310
<b>S40-08F</b>	850	760	440	310	720	310
<b>S40-10F</b>	1050	960	440	310	920	310

Connection dimensions Airbox S40 standard units (rectangular/quadratic):

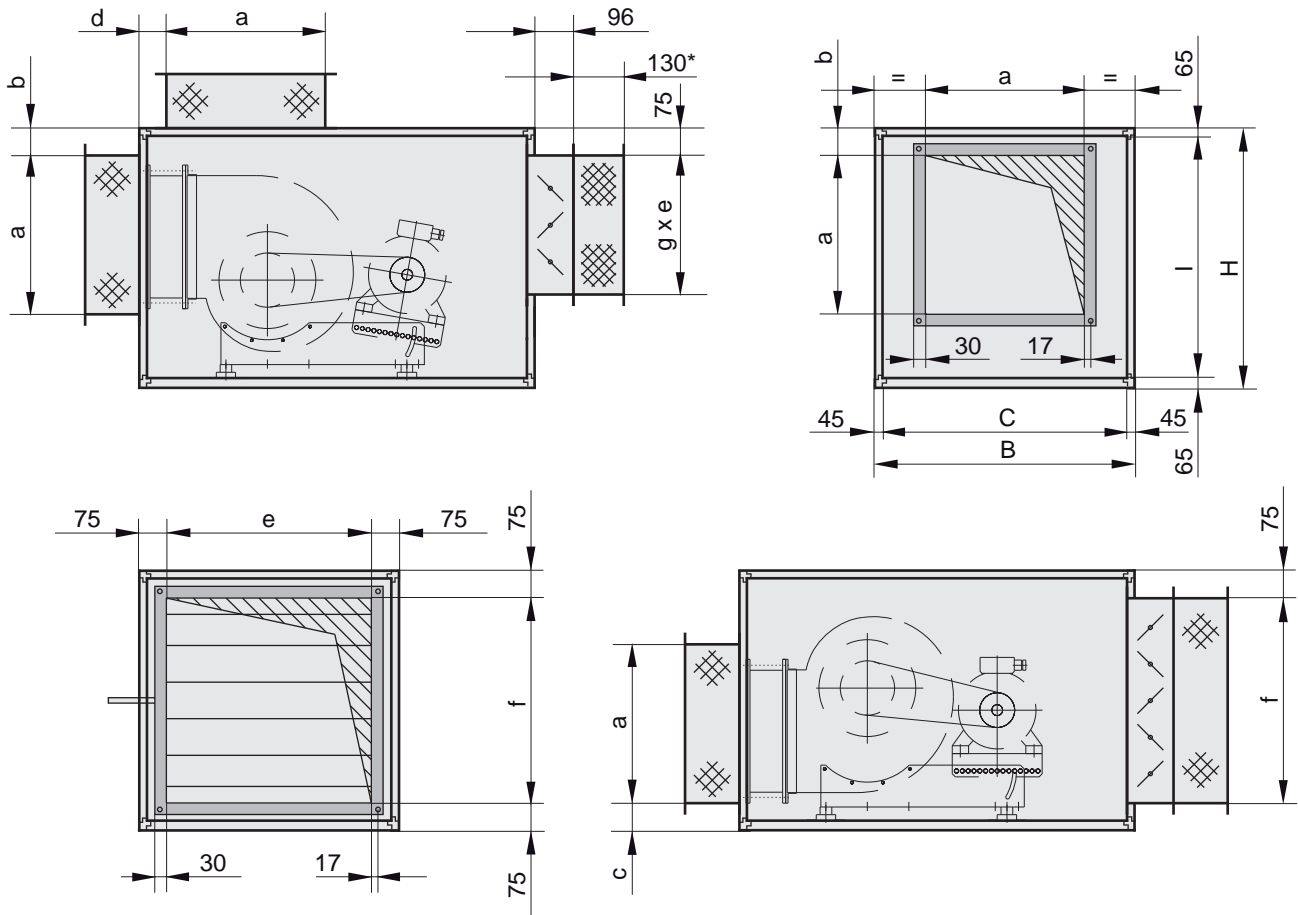

\* Installation length 130mm, total length 140mm / all dimensions in mm

Size	B	C	H	I	a	b	c	d	e	f	g
S40-07Q	730	640	730	600	410	100	100	100	580	580	375
S40-08Q	850	760	850	720	500	100	100	100	700	700	375
S40-10R	1050	960	730	600	500	100	100	100	900	580	375
S40-10Q	1050	960	1050	920	580	100/200	200/100	100	900	900	375
S40-13R	1350	1260	1050	920	700	100	100	100	1200	900	615
S40-13Q	1350	1260	1350	1240	700	150/100 <sup>1)</sup>	250	100	1200	1200	615
S40-16R	1680	1590	1350	1240	900	100	100	100	1530	1200	615
S40-16Q	1680	1590	1680	1550	900	250	250	120	1530	1530	615
S40-20R	1980	1890	1680	1550	1000	250/120 <sup>1)</sup>	250	120	1830	1530	855
S40-20Q	1980	1890	1980	1850	1000	400/260 <sup>1)</sup>	270/315 <sup>1)</sup>	120	1830	1830	855
S40-22R	2220	2130	1980	1850	1000	)	)	120	2070	1830	855
S40-22Q	2220	2130	2220	2090	)	)	)	120	2070	2070	855
S40-25R	2530	2440	2220	2090	)	)	)	120	2380	2070	1095
S40-25Q	2530	2440	2530	2400	)	)	)	120	2380	2380	1095
S40-28R	2830	2740	2530	2400	)	)	)	120	2680	2380	1095

<sup>1)</sup> depends on the type of fan and the casing position



**Casing design:**

S60 units have a frame made from rolled, galvanised steel profiles and corner connectors made from die-cast aluminium or fibreglass-reinforced plastic. The aluminium die cast corner connectors can be supplied with or without M20 threads in order to attach crane lugs, for example. Frame profiles and aluminium die-cast connectors are sealed against one another by EPDM seals. The panels of the casing are a double skin construction with a 60 mm wall thickness. In the basic version, 1,0 mm thick galvanised steel sheet is used for the inside and outside sheets. Alternatively, the S60 casings are available with plastic coating (standard RAL 7035), in V2A (AISI 304)

or with aluminium panelling AlMg3. The rock wool used as thermal and acoustic insulation is non-flammable and is partly glued onto the double skin. The panels are screwed onto the hollow frame profile from the outside. The connections between the casing components are configured so the insides are smooth. The units up size 13Q can be provided with a folded base frame made from 3 mm thick galvanised steel sheet. Alternatively, welded steel base frames in a galvanised or painted configuration are available for larger sizes. S60 units are suitable for meeting the hygiene regulations of VDI 6022 and DIN 1946 T4.

**Mechanical and thermal performance (acc. to EN 1886, 2007):**

Thermal transmittance (coefficient of thermal transmittance U) [W/m²K]	Thermal bridging factor k <sub>b</sub> [-]	Filter bypass leakage	Casing leakage				
			Test pressure -400 Pa [dm³ x s⁻¹ x m⁻²]	Test pressure +700 Pa [dm³ x s⁻¹ x m⁻²]			
0,91 (T2)	0,55 (TB3)	F9 (0,36 %)	L2 (0,287)	L2 (0,389)			
Sheet thickness of outside sheet / inside sheet [mm]	Insulating material / density [kg/m³]	Casing stability [mm/m]	Weight of side panels [kg/m²]	Fire protection class of the insulation [-]			
1,0 / 1,0 (reinforced 1,25 / 1,25)	rock wool / 40-90	D1 [3,5]	22	A1			
Octave band for casing sound insertion loss							
Frequency [Hz]	125	250	500	1000	2000	4000	8000
Sound insertion loss index [dB]	20	36	37	37	42	42	36

Airbox - S60								
Airbox Type	Unit face [m <sup>2</sup> ]	Flow rate by air velocity [m <sup>3</sup> /h]			External dimensions		Internal dimensions	
		1,0 m/s	2,0 m/s	4,0 m/s	width [mm]	height [mm]	width [mm]	height [mm]
<b>S60-07Q</b>	0,410	1400	2900	5900	770	770	640	640
<b>S60-08Q</b>	0,578	2000	4100	8300	890	890	760	760
<b>S60-10R</b>	0,614	2200	4400	8800	1090	770	960	640
<b>S60-10Q</b>	0,922	3300	6600	13200	1090	1090	960	960
<b>S60-13R</b>	1,210	4300	8700	17400	1390	1090	1260	960
<b>S60-13Q</b>	1,588	5700	11400	22800	1390	1390	1260	1260
<b>S60-16R</b>	2,003	7200	14400	28800	1720	1390	1590	1260
<b>S60-16Q</b>	2,528	9100	18200	36400	1720	1720	1590	1590
<b>S60-20R</b>	3,005	10800	21600	43200	2020	1720	1890	1590
<b>S60-20Q</b>	3,572	12800	25700	51400	2020	2020	1890	1890
<b>S60-22R</b>	4,026	14400	28900	57900	2260	2020	2130	1890
<b>S60-22Q</b>	4,537	16300	32600	65300	2260	2260	2130	2130
<b>S60-25R</b>	5,197	18700	37400	74800	2570	2260	2440	2130
<b>S60-25Q</b>	5,954	21400	42800	85700	2570	2570	2440	2440
<b>S60-28R</b>	6,686	24000	48100	96200	2870	2570	2740	2440
<b>S60-28Q</b>	7,508	27000	54000	108100	2870	2870	2740	2740
<b>S60-32R</b>	8,357	30000	60100	120300	3180	2870	3050	2740
<b>S60-35R</b>	9,179	33000	66000	132100	3480	2870	3350	2740

**Panel connection:**

The panels are screwed onto the connecting profile from outside. In order to provide a good visual look, the screws on the outsides of the casing are concealed. A sealing strip is glued between the panels and profile.

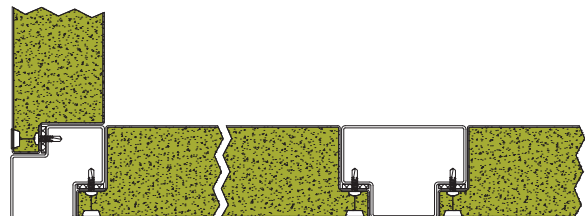
**Module connection:**

The modules are connected in different ways depending on their size. The supplied self-adhesive sealing tape (40 mm x 3 mm) must be affixed to one of the two modules which are to be connected. Folded gusset plates are installed in the cor-



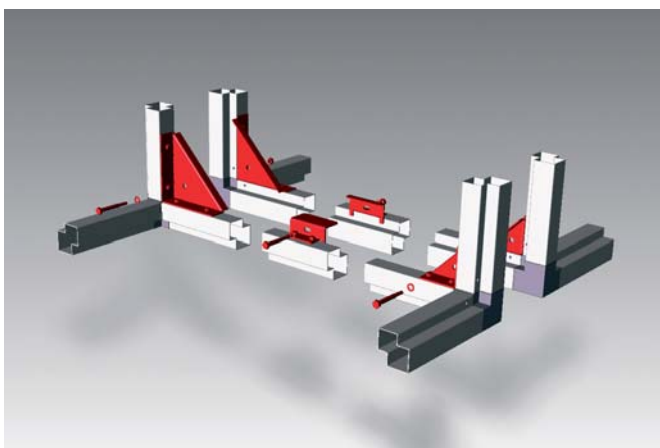





ners at the factory. The modules are tightened onto these with supplied screws M8 x 110 mm. In modules from unit size 13R upwards, it is necessary to set additional module connectors along the edges of the unit face.













Size	Folded gusset plate	Module connector (vertical connection)	Module connector (horizontal connection)
<b>07Q - 10Q</b>	4 pcs. (small corners)	-	-
<b>13R</b>	4 pcs. (small corners)	-	1 pcs.
<b>13Q - 16Q</b>	4 pcs. (small corners)	1 pcs.	1 pcs.
<b>20R</b>	4 pcs. (small corners)	1 pcs.	2 pcs.
<b>20Q - 28R</b>	4 pcs. (large corners)	2 pcs.	2 pcs.
<b>28Q</b>	4 pcs. (large corners)	2 pcs.	2 pcs.
<b>32R - 35R</b>	4 pcs. (large corners)	3 pcs.	2 pcs.



S60 - Module dimensions of the components [mm]											
Module	Symbol	dimens.	07Q	08Q	10R	10Q	13R	13Q	16R	16Q	20R
Belt driven centrifugal fans		L	1050	1050	1050	1290	1530	1530	1770	2010	2250
		B	770	890	1090	1090	1390	1390	1720	1720	2020
		H	770	890	770	1090	1090	1390	1390	1720	1720
Free running impeller with external rotor motor (AC- / EC-Technic)		L	810	810	810	810	1050	1050	1170	1170	-
		B	770	890	1090	1090	1390	1390	1720	1720	-
		H	770	890	770	1090	1090	1390	1390	1720	-
Free running impeller with IEC standard motor		L	810	1050	810	1290	1290	1290	1290	1530	1530
		B	770	890	1090	1090	1390	1390	1720	1720	2020
		H	770	890	770	1090	1090	1390	1390	1720	1720
Direct driven centrifugal fans		L	810	810	810	1050	1050	1290	1290	1290	-
		B	770	890	1090	1090	1390	1390	1720	1720	-
		H	770	890	770	1090	1090	1390	1390	1720	-
Filter Z-line		L	330	330	330	330	-	-	-	-	-
		B	770	890	1090	1090	-	-	-	-	-
		H	770	890	770	1090	-	-	-	-	-
Bag filter <sup>3)</sup> M5 - F9 L = 600mm		L	810	810	810	810	810	810	810	810	810
		B	770	890	1090	1090	1390	1390	1720	1720	2020
		H	770	890	770	1090	1090	1390	1390	1720	1720
Bag filter <sup>3)</sup> G4 L=360mm		L	570	570	570	570	570	570	570	570	570
		B	770	890	1090	1090	1390	1390	1720	1720	2020
		H	770	890	770	1090	1090	1390	1390	1720	1720
Panel filter G4, M5 - F9 L = 94mm		L	570	570	570	570	570	570	570	570	570
		B	770	890	1090	1090	1390	1390	1720	1720	2020
		H	770	890	770	1090	1090	1390	1390	1720	1720
Compact filter		L	570	570	570	570	570	570	570	570	570
		B	770	890	1090	1090	1390	1390	1720	1720	2020
		H	770	890	770	1090	1090	1390	1390	1720	1720
Metal filter weaved		L	330	330	330	330	570	570	-	-	-
		B	770	890	1090	1090	1390	1390	-	-	-
		H	770	890	770	1090	1090	1390	-	-	-
Carbon filter		L	810	810	810	810	810	810	810	810	810
		B	770	890	1090	1090	1390	1390	1720	1720	2020
		H	770	890	770	1090	1090	1390	1390	1720	1720
HEPA filter		L	810	810	810	810	810	810	810	810	810
		B	770	890	1090	1090	1390	1390	1720	1720	2020
		H	770	890	770	1090	1090	1390	1390	1720	1720

S60 - Module dimensions of the components [mm]											
Module	Symbol	dimens.	20Q	22R	22Q	25R	25Q	28R	28Q	32R	35R
<b>Belt driven centrifugal fans</b>		L	2445	2445	2685	2925	2925	2925	2925	2925	2925
		B	2020	2260	2260	2570	2570	2870	2870	3180	3480
		H	2020	2020	2260	2260	2570	2570	2870	2870	2870
<b>Free running impeller with external rotor motor (AC- / EC-Technic)</b>		L	-	-	-	-	-	-	-	-	-
		B	-	-	-	-	-	-	-	-	-
		H	-	-	-	-	-	-	-	-	-
<b>Free running impeller with IEC standard motor</b>		L	1725	1725	1965	1965	1965	1965	1965	1965	1965
		B	2020	2260	2260	2570	2570	2870	2870	3180	3480
		H	2020	2020	2260	2260	2570	2570	2870	2870	2870
<b>Direct driven centrifugal fans</b>		L	-	-	-	-	-	-	-	-	-
		B	-	-	-	-	-	-	-	-	-
		H	-	-	-	-	-	-	-	-	-
<b>Filter Z - line</b>		L	-	-	-	-	-	-	-	-	-
		B	-	-	-	-	-	-	-	-	-
		H	-	-	-	-	-	-	-	-	-
<b>Bag filter <sup>3)</sup> M5 - F9 L = 600mm</b>		L	765	765	765	765	765	765	765	765	765
		B	2020	2260	2260	2570	2570	2870	2870	3180	3480
		H	2020	2020	2260	2260	2570	2570	2870	2870	2870
<b>Bag filter <sup>3)</sup> G4 L=360mm</b>		L	525	525	525	525	525	525	525	525	525
		B	2020	2260	2260	2570	2570	2870	2870	3180	3480
		H	2020	2020	2260	2260	2570	2570	2870	2870	2870
<b>Panel filter G4, M5 - F9 L = 94mm</b>		L	525	525	525	525	525	525	525	525	525
		B	2020	2260	2260	2570	2570	2870	2870	3180	3480
		H	2020	2020	2260	2260	2570	2570	2870	2870	2870
<b>Compact filter</b>		L	765	765	765	765	765	765	765	765	765
		B	2020	2260	2260	2570	2570	2870	2870	3180	3480
		H	2020	2020	2260	2260	2570	2570	2870	2870	2870
<b>Metal filter weaved</b>		L	-	-	-	-	-	-	-	-	-
		B	-	-	-	-	-	-	-	-	-
		H	-	-	-	-	-	-	-	-	-
<b>Carbon filter</b>		L	765	-	-	-	-	-	-	-	-
		B	2020	-	-	-	-	-	-	-	-
		H	2020	-	-	-	-	-	-	-	-
<b>HEPA filter</b>		L	765	-	-	-	-	-	-	-	-
		B	1020	-	-	-	-	-	-	-	-
		H	2020	-	-	-	-	-	-	-	-

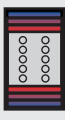
S60 - Module dimensions of the components [mm]												
Module	Symbol	dimens.	07Q	08Q	10R	10Q	13R	13Q	16R	16Q	20R	
<b>Heater</b> L1 = 1 - 3 RR L2 = 4 - 6 RR L3 = 8 RR		L1	330	330	330	330	330	330	330	330	330	
		L2	330	330	330	330	330	330	330	330	330	
		L3	570	570	570	570	570	570	570	570	570	
		B	770	890	1090	1090	1390	1390	1720	1720	2020	
		H	770	890	770	1090	1090	1390	1390	1720	1720	
<b>Cooler</b> L1 = 1 - 3 RR L2 = 4 - 6 RR L3 = 8 RR		L1	570	570	570	570	570	570	570	810	1050	
		L2	570	570	570	570	570	570	810	1050	1050	
		L3	810	810	810	810	810	810	810	810	1050	1050
		B	770	890	1090	1090	1390	1390	1720	1720	2020	
		H	770	890	770	1090	1090	1390	1390	1720	1720	
<b>Evaporator</b> L1 = 1 - 3 RR L2 = 4 - 6 RR L3 = 8 RR		L1	570	570	570	570	570	570	570	810	1050	
		L2	570	570	570	570	570	570	810	1050	1050	
		L3	810	810	810	810	810	810	810	810	1050	1050
		B	770	890	1090	1090	1390	1390	1720	1720	2020	
		H	770	890	770	1090	1090	1390	1390	1720	1720	
<b>Electric heater</b>		L	570	570	570	570	570	570	-	-	-	
		B	770	890	1090	1090	1390	1390	-	-	-	
		H	770	890	770	1090	1090	1390	-	-	-	
<b>Sound attenuator:</b> Typ 1, Typ 2, Typ 3, Typ 4, Typ 5		L1	1050	1050	1050	1050	1050	1050	1050	1050	1050	
		L2	1290	1290	1290	1290	1290	1290	1290	1290	1290	
		L3	1530	1530	1530	1530	1530	1530	1530	1530	1530	
		L4	1770	1770	1770	1770	1770	1770	1770	1770	1770	
		L5	2010	2010	2010	2010	2010	2010	2010	2010	2010	
<b>Crossflow heat exchanger <sup>1)</sup></b>		L	1290	1770	1290	1770	2010	2490	2490	3255	3255	
		B	770	890	1090	1090	1390	1390	1720	1720	2020	
		H	1540	1780	1540	2180	2180	2780	2780	3440	3440	
<b>Crossflow heat exchanger <sup>2)</sup></b>		L	1290	1770	1770	1770	2010	2490	2490	3255	3255	
		B	1540	1780	2180	2180	2780	2780	3440	3440	4040	
		H	770	890	770	1090	1090	1390	1390	1720	1720	
<b>Rotary heat exchanger</b> L1 = without flow metering unit L2 = including flow metering unit		L1	810	810	810	810	810	810	810	810	810	
		L2	1530	1530	1530	1530	1530	1530	1530	1530	1530	
		B	1050	1290	1290	1530	1680	1980	2010	2490	2490	
		H	1540	1780	1540	2180	2180	2780	2780	3440	3440	
<b>Heat pipe</b> 4 - 8 RR including droplet eliminator		L	810	810	810	810	810	810	810	1050	1050	
		B	770	890	1090	1090	1390	1390	1720	1720	2020	
		H	1540	1780	1540	2180	2180	2780	2780	3440	3440	
<b>Mixing unit</b>		L	570	570	570	570	810	810	810	810	1050	
		B	770	890	1090	1090	1390	1390	1720	1720	2020	
		H	770	890	770	1090	1090	1390	1390	1720	1720	
<b>Frost protection frame</b>		L	330	330	330	330	330	330	330	330	330	
		B	770	890	1090	1090	1390	1390	1720	1720	2020	
		H	770	890	770	1090	1090	1390	1390	1720	1720	

S60 - Module dimensions of the components [mm]												
Module	Symbol	dimens.	20Q	22R	22Q	25R	25Q	28R	28Q	32R	35R	
<b>Heater</b> L1 = 1 - 3 RR L2 = 4 - 6 RR L3 = 8 RR		L1	525	-	-	-	-	-	-	-	-	
		L2	525	525	525	525	525	525	525	525	525	
		L3	525	-	-	-	-	-	-	-	-	-
		B	2020	2260	2260	2570	2570	2870	2870	3180	3480	
		H	2020	2020	2260	2260	2570	2570	2870	2870	2870	
<b>Cooler</b> L1 = 1 - 3 RR L2 = 4 - 6 RR L3 = 8 RR		L1	1005	-	-	-	-	-	-	-	-	
		L2	1005	1005	1005	1005	1005	1005	1005	1005	1005	
		L3	1005	-	-	-	-	-	-	-	-	-
		B	2020	2260	2260	2570	2570	2870	2870	3180	3480	
		H	2020	2020	2260	2260	2570	2570	2870	2870	2870	
<b>Evaporator</b> L1 = 1 - 3 RR L2 = 4 - 6 RR L3 = 8 RR		L1	1005	1005	1005	1005	1005	1005	1005	1005	1005	
		L2	1005	1005	1005	1005	1005	1005	1005	1005	1005	
		L3	1005	1005	1005	1005	1005	1005	1005	1005	1005	
		B	1980	2220	2220	2530	2530	2830	2870	3180	3480	
		H	1980	1980	2220	2220	2530	2530	2830	2870	2870	
<b>Electric heater</b>		L	-	-	-	-	-	-	-	-	-	
		B	-	-	-	-	-	-	-	-	-	
		H	-	-	-	-	-	-	-	-	-	
<b>Sound attenuator:</b> Typ 1, Typ 2, Typ 3, Typ 4, Typ 5		L1	1245	1245	1245	1245	1245	1245	1245	1245	1245	
		L2	1485	1485	1485	1485	1485	1485	1485	1485	1485	
		L3	1725	1725	1725	1725	1725	1725	1725	1725	1725	
		L4	1965	1965	1965	1965	1965	1965	1965	1965	1965	
		L5	2205	2205	2205	2205	2205	2205	2205	2205	2205	
<b>Crossflow heat exchanger <sup>1)</sup></b>		L	3255	3255	-	-	-	-	-	-	-	
		B	1980	2220	-	-	-	-	-	-	-	
		H	4040	4040	-	-	-	-	-	-	-	
<b>Crossflow heat exchanger <sup>2)</sup></b>		L	3255	3255	-	-	-	-	-	-	-	
		B	4040	4520	-	-	-	-	-	-	-	
		H	2020	2020	-	-	-	-	-	-	-	
<b>Rotary heat exchanger</b> L1 = without flow metering unit L2 = including flow metering unit		L1	765	765	765	765	765	765				
		L2	1485	1725	1725	1965	1965	1965	on request	on request	on request	
		B	2730	2970	3210	3450	3690	3690				
		H	3960	3960	4440	4440	5060	5060				
<b>Heat pipe</b> 4 - 8 RR including droplet eliminator		L	1050	1005	-	-	-	-	-	-	-	
		B	1980	2220	-	-	-	-	-	-	-	
		H	3960	3960	-	-	-	-	-	-	-	
<b>Mixing unit</b>		L	1050	1005	1005	1245	1245	1245	1245	1245	1245	
		B	2020	2260	2260	2570	2570	2870	2870	3180	3480	
		H	2020	2020	2260	2260	2570	2570	2870	2870	2870	
<b>Frost protection frame</b>		L	285	330	-	-	-	-	-	-	-	
		B	2020	2260	-	-	-	-	-	-	-	
		H	2020	2020	-	-	-	-	-	-	-	

1) Dimensions arrangement one upon the other

2) Dimensions arrangement side by side

3) for filter service on dusty air side (VDI 6022) an additional service module is necessary. Alternatively Rosenberg terminal strip system is possible.

Connection dimensions Airbox S60 - Standard units (rectangular/quadratic):

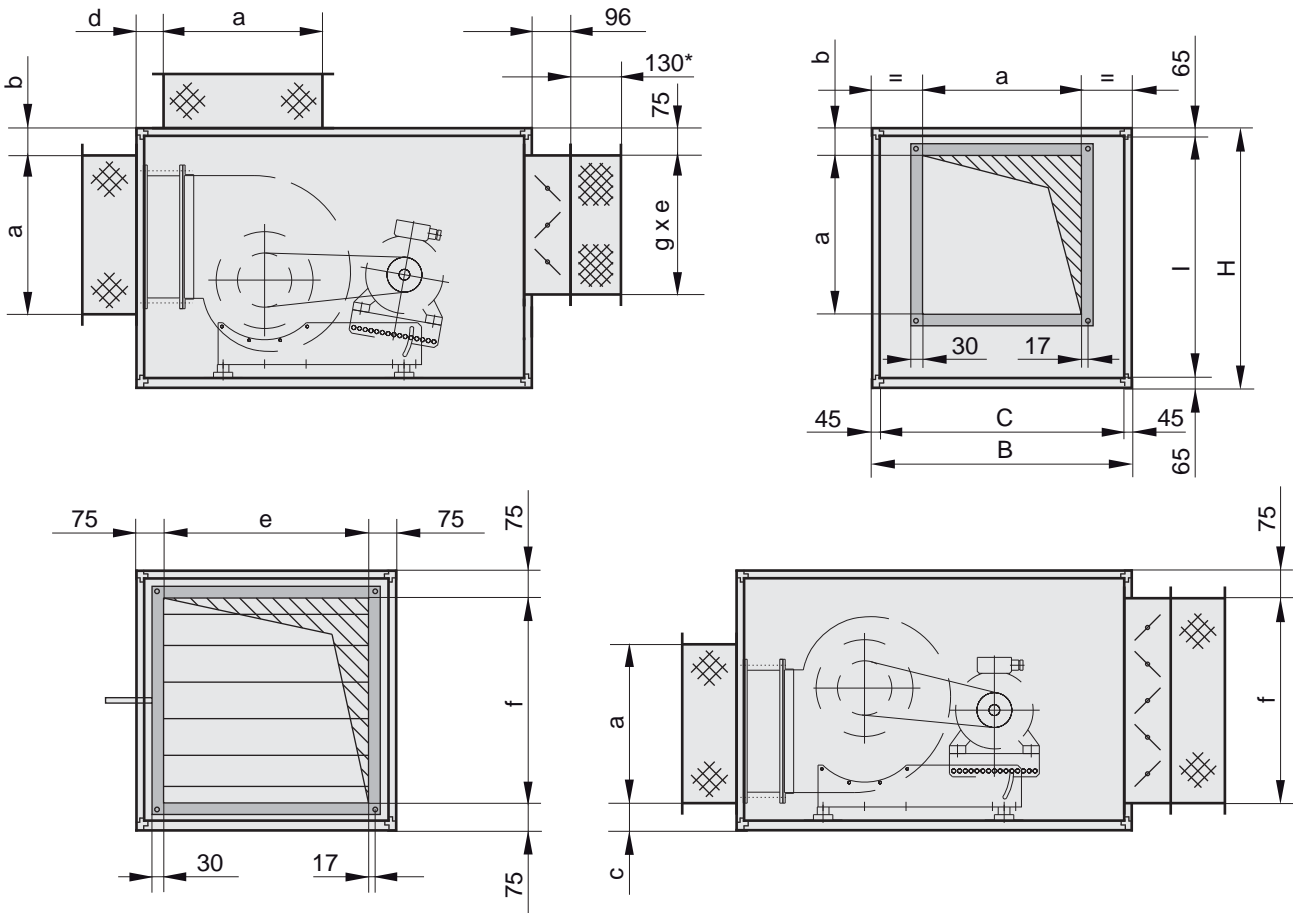

\* Installation length 130 mm, total length 140mm / all dimensions in mm

Size	B	C	H	I	a	b	c	d	e	f	g
S60-07Q	770	640	770	640	410	120	120	120	620	620	375
S60-08Q	890	760	890	760	500	120	120	120	740	740	375
S60-10R	1090	960	770	640	500	120	120	120	940	620	375
S60-10Q	1090	960	1090	960	580	120/220	220/120	120	940	940	375
S60-13R	1390	1260	1090	960	700	120	120	120	1240	940	615
S60-13Q	1390	1260	1390	1260	700	170/270	270	120	1240	1240	615
S60-16R	1720	1590	1390	1260	900	120	120	120	1570	1240	615
S60-16Q	1720	1590	1720	1590	900	270	270	140	1570	1570	615
S60-20R	2020	1890	1720	1590	1000	270	270	140	1870	1570	855
S60-20Q	2020	1890	2020	1890	1000	420/270	290/305	140	1870	1870	855
S60-22R	2260	2130	2020	1890	1000	)	)	140	2110	1870	855
S60-22Q	2260	2130	2260	2130	)	)	)	140	2110	2110	855
S60-25R	2570	2440	2260	2130	)	)	)	140	2420	2110	1095
S60-25Q	2570	2440	2570	2440	)	)	)	140	2420	2420	1095
S60-28R	2870	2740	2570	2440	)	)	)	140	2720	2420	1095
S60-28Q	2870	2740	2870	2740	)	)	)	140	2720	2720	1095
S60-32R	3180	3050	2870	2740	)	)	)	140	3030	2720	1095
S60-35R	3480	3350	2870	2740	)	)	)	140	3330	2720	1095

) depends on the type of fan and the casing position



Reference object: Würth Elektronik, Niedernhall (Germany)  
6 AHU's with air volumes from 5.500 - 44.000 m<sup>3</sup>/h

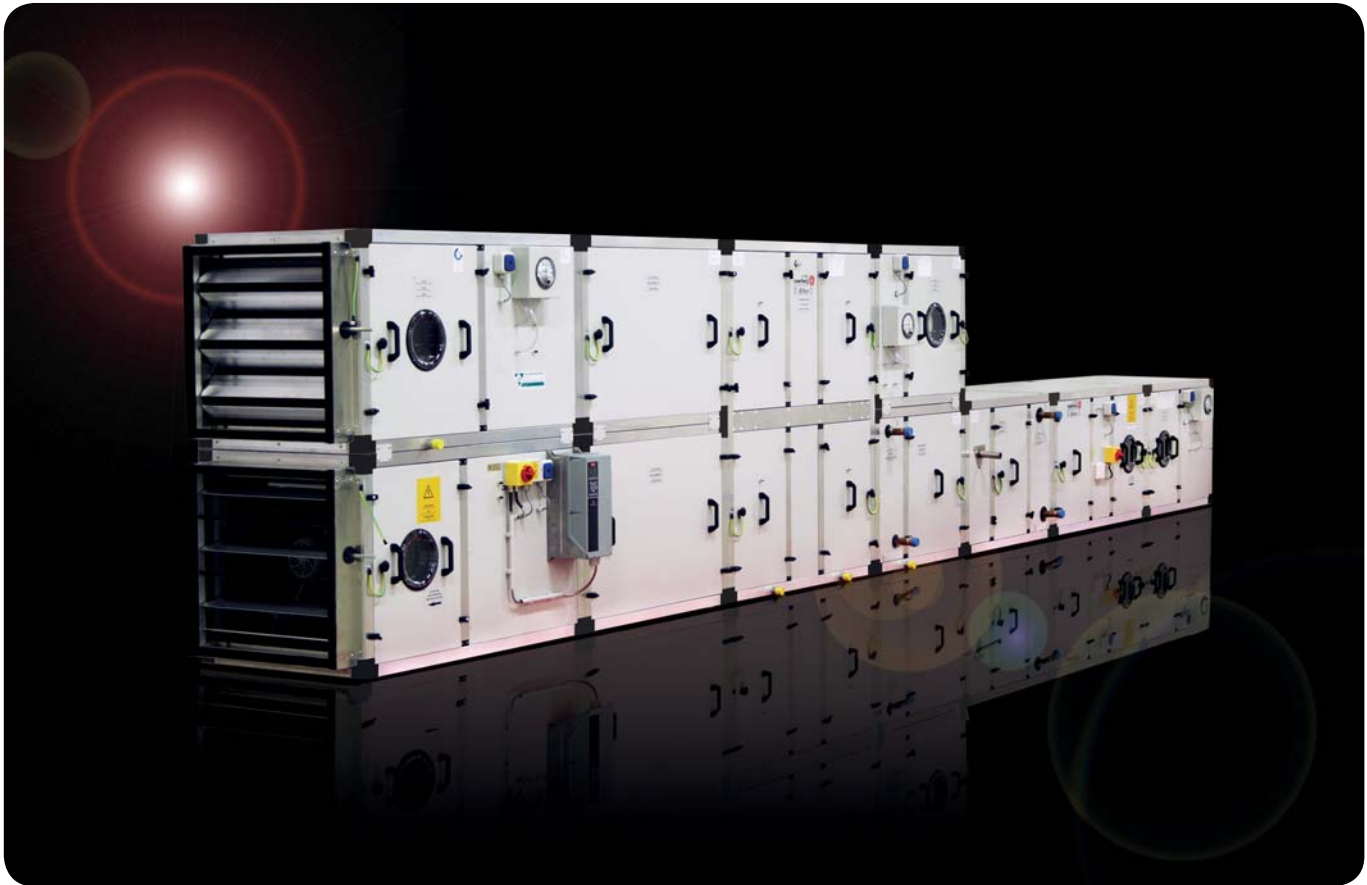

**Casing design**

The Airbox T60 devices have a thermally decoupled aluminium frame with gutters and corner connections made of fibreglass reinforced polyamide which are also thermally decoupled. Frame profiles and plastic corner connectors are sealed against each other using EPDM seals. The thermally decoupled casing panels are of double-skin construction with a 60 mm wall thickness. In the basic version, 1 mm thick galvanised steel sheet is used for the inside and outside sheets. Alternatively, the T60 casings are available with plastic coating (standard RAL 7035), in V2A 1.4301 or with aluminium panelling AlMg3. The rock wool used as thermal and acoustic insulation is non-flammable and is partly glued onto the double-skin panel. The

panels are screwed on to the hollow frame profile from the outside. The connections between the casing components are configured so the insides are smooth. Lifting lugs can be attached due to the decoupled frame profile exclusively on the base frame under the housing.

The T60 series is Eurovent-certified. The suitability for the highest hygienic standards is demonstrated by the TÜV certification to DIN1946/T4 and VDI6022.

**Mechanical and thermal performance (acc. to EN 1886, 2007):**

Thermal transmittance (coefficient of thermal transmittance U) [W/m²K]	Thermal bridging factor $k_b$ [-]	Filter bypass leakage	Casing leakage				
			Test pressure-400 Pa [dm³ x s⁻¹ x m²]	Test pressure +700 Pa [dm³ x s⁻¹ x m²]			
0,80 (T2)	(TB2)	F9 (0,26 %)	L1 (M) [0,07]	L1 (M) [0,11]			
Sheet thickness of outside sheet / inside sheet [mm]	Insulating material / density [kg/m³]	Casing stability [mm/m]	Weight of side panels [kg/m²]	Fire protection class of the insulation [-]			
1,0 / 1,0 (reinforced1,25 / 1,25)	rock wool / 40-90	D2 (M) [5,4]	22	A1			
Octave band for casing sound insertion loss							
Frequency [Hz]	125	250	500	1000	2000	4000	8000
Sound insertion loss index [dB]	15	25	28	30	29	31	35

Airbox - T60								
Airbox Type	Unit Face [m <sup>2</sup> ]	Flow rate by air velocity [m <sup>3</sup> /h]			External dimensions		Internal dimensions	
		1,0 m/s	2,0 m/s	4,0 m/s	width [mm]	height [mm]	width [mm]	height [mm]
<b>T60-07Q</b>	0,410	1400	2900	5900	770	770	640	640
<b>T60-08Q</b>	0,578	2000	4100	8300	890	890	760	760
<b>T60-10R</b>	0,614	2200	4400	8800	1090	770	960	640
<b>T60-10Q</b>	0,922	3300	6600	13200	1090	1090	960	960
<b>T60-13R</b>	1,210	4300	8700	17400	1390	1090	1260	960
<b>T60-13Q</b>	1,588	5700	11400	22800	1390	1390	1260	1260
<b>T60-16R</b>	2,003	7200	14400	28800	1720	1390	1590	1260
<b>T60-16Q</b>	2,528	9100	18200	36400	1720	1720	1590	1590
<b>T60-20R</b>	3,005	10800	21600	43200	2020	1720	1890	1590
<b>T60-20Q</b>	3,572	12800	25700	51400	2020	2020	1890	1890
<b>T60-22R</b>	4,026	14400	28900	57900	2260	2020	2130	1890
<b>T60-22Q</b>	4,537	16300	32600	65300	2260	2260	2130	2130
<b>T60-25R</b>	5,197	18700	37400	74800	2570	2260	2440	2130
<b>T60-25Q</b>	5,954	21400	42800	85700	2570	2570	2440	2440
<b>T60-28R</b>	6,686	24000	48100	96200	2870	2570	2740	2440

**Panel connection:**

The panels are screwed onto the connecting profile from outside. In order to provide a good visual look, the screws on the outsides of the casing are concealed. A sealing strip is glued between the panels and profile.

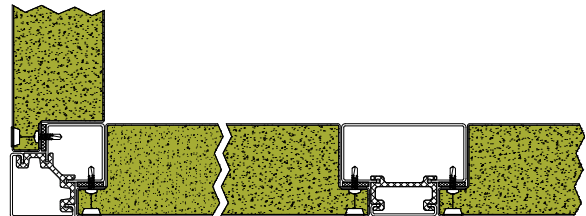
**Module connection:**

The modules are connected in different ways depending on their size. The supplied self-adhesive sealing tape (40 mm x 3 mm) must be affixed to one of the two modules which are to be connected. Folded gusset plates are installed in the cor-

ners at the factory. The modules are tightened onto these with supplied screws M8 x 110 mm. In modules from unit size 13R upwards, it is necessary to set additional module connectors are to be placed along the edges of the unit cross-section.















Size	Folded gusset plate	Module connector (vertical connection)	Module connector (horizontal connection)
<b>07Q - 10Q</b>	4 pcs. (small corners)	-	-
<b>13R</b>	4 pcs. (small corners)	-	1 pcs.
<b>13Q - 16Q</b>	4 pcs. (small corners)	1 pcs.	1 pcs.
<b>20R</b>	4 pcs. (small corners)	1 pcs.	2 pcs.
<b>20Q - 28R</b>	4 pcs. (large corners)	2 pcs.	2 pcs.
<b>28Q</b>	4 pcs. (large corners)	2 pcs.	2 pcs.
<b>32R - 35R</b>	4 pcs. (large corners)	3 pcs.	2 pcs.













T60 - Module dimensions of the components [mm]										
Module	Symbol	dimens.	07Q	08Q	10R	10Q	13R	13Q	16R	16Q
Belt driven centrifugal fans		L	1050	1050	1050	1290	1530	1530	1770	2010
		B	770	890	1090	1090	1390	1390	1720	1720
		H	770	890	770	1090	1090	1390	1390	1390
Free running impeller with external rotor motor (AC- / EC-Technic)		L	810	810	810	810	1050	1050	1170	1170
		B	770	890	1090	1090	1390	1390	1720	1720
		H	770	890	770	1090	1090	1390	1390	1390
Free running impeller with IEC standard motor		L	810	1050	810	1290	1290	1290	1290	1530
		B	770	890	1090	1090	1390	1390	1720	1720
		H	770	890	770	1090	1090	1390	1390	1390
Direct driven centrifugal fans		L	810	810	810	1050	1050	1290	1290	1290
		B	770	890	1090	1090	1390	1390	1720	1720
		H	770	890	770	1090	1090	1390	1390	1390
Filter Z-line		L	330	330	330	330	-	-	-	-
		B	770	890	1090	1090	-	-	-	-
		H	770	890	770	1090	-	-	-	-
Bag filter <sup>3)</sup> M5 - F9 L = 600mm		L	810	810	810	810	810	810	810	810
		B	770	890	1090	1090	1390	1390	1720	1720
		H	770	890	770	1090	1090	1390	1390	1390
Bag filter <sup>3)</sup> G4 L=360mm		L	570	570	570	570	570	570	570	570
		B	770	890	1090	1090	1390	1390	1720	1720
		H	770	890	770	1090	1090	1390	1390	1390
Panel filter G4, M5 - F9 L = 94mm		L	570	570	570	570	570	570	570	570
		B	770	890	1090	1090	1390	1390	1720	1720
		H	770	890	770	1090	1090	1390	1390	1390
Compact filter		L	570	570	570	570	570	570	570	570
		B	770	890	1090	1090	1390	1390	1720	1720
		H	770	890	770	1090	1090	1390	1390	1390
Metal filter weaved		L	330	330	330	330	570	570	-	-
		B	770	890	1090	1090	1390	1390	-	-
		H	770	890	770	1090	1090	1390	-	-
Carbon filter		L	810	810	810	810	810	810	810	810
		B	770	890	1090	1090	1390	1390	1720	1720
		H	770	890	770	1090	1090	1390	1390	1390
HEPA filter		L	810	810	810	810	810	810	810	810
		B	770	890	1090	1090	1390	1390	1720	1720
		H	770	890	770	1090	1090	1390	1390	1390

**T60 - Module dimensions of the components [mm]**

Module	Symbol	dimens.	20R	20Q	22R	22Q	25R	25Q	28R
<b>Belt driven centrifugal fans</b>		L	2250	2445	2445	2685	2925	2925	2925
		B	2020	2020	2260	2260	2570	2570	2870
		H	1720	2020	2020	2260	2260	2570	2570
<b>Free running impeller with external rotor motor (AC- / EC-Technic)</b>		L	-	-	-	-	-	-	-
		B	-	-	-	-	-	-	-
		H	-	-	-	-	-	-	-
<b>Free running impeller with IEC standard motor</b>		L	1530	1725	1725	1965	1965	1965	1965
		B	2020	2020	2260	2260	2570	2570	2870
		H	1720	2020	2020	2260	2260	2570	2570
<b>Direct driven centrifugal fans</b>		L	-	-	-	-	-	-	-
		B	-	-	-	-	-	-	-
		H	-	-	-	-	-	-	-
<b>Filter Z-line</b>		L	-	-	-	-	-	-	-
		B	-	-	-	-	-	-	-
		H	-	-	-	-	-	-	-
<b>Bag filter<sup>3)</sup> M5 - F9 L = 600mm</b>		L	810	765	765	765	765	765	765
		B	2020	2020	2260	2260	2570	2570	2870
		H	1720	2020	2020	2260	2260	2570	2570
<b>Bag filter<sup>3)</sup> G4 L=360mm</b>		L	570	525	525	525	525	525	525
		B	2020	2020	2260	2260	2570	2570	2870
		H	1720	2020	2020	2260	2260	2570	2570
<b>Panel filter G4, M5 - F9 L = 94mm</b>		L	570	525	525	525	525	525	525
		B	2020	2020	2260	2260	2570	2570	2870
		H	1720	2020	2020	2260	2260	2570	2570
<b>Compact filter</b>		L	570	765	765	765	765	765	765
		B	2020	2020	2260	2260	2570	2570	2870
		H	1720	2020	2020	2260	2260	2570	2570
<b>Metal filter weaved</b>		L	-	-	-	-	-	-	-
		B	-	-	-	-	-	-	-
		H	-	-	-	-	-	-	-
<b>Carbon filter</b>		L	810	765	-	-	-	-	-
		B	2020	2020	-	-	-	-	-
		H	1720	2020	-	-	-	-	-
<b>HEPA filter</b>		L	810	765	-	-	-	-	-
		B	2020	1020	-	-	-	-	-
		H	1720	2020	-	-	-	-	-

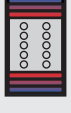
T60 - Module dimensions of the components [mm]											
Module	Symbol	dimens.	07Q	08Q	10R	10Q	13R	13Q	16R	16Q	
<b>Heater</b> L1 = 1 - 3 RR L2 = 4 - 6 RR L3 = 8 RR		L1	330	330	330	330	330	330	330	330	
		L2	330	330	330	330	330	330	330	330	
		L3	570	570	570	570	570	570	570	570	
		B	770	890	1090	1090	1390	1390	1720	1720	
		H	770	890	770	1090	1090	1390	1390	1720	
<b>Cooler</b> L1 = 1 - 3 RR L2 = 4 - 6 RR L3 = 8 RR		L1	570	570	570	570	570	570	570	810	
		L2	570	570	570	570	570	570	810	1050	
		L3	810	810	810	810	810	810	810	810	1050
		B	770	890	1090	1090	1390	1390	1720	1720	
		H	770	890	770	1090	1090	1390	1390	1720	
<b>Evaporator</b> L1 = 1 - 3 RR L2 = 4 - 6 RR L3 = 8 RR		L1	570	570	570	570	570	570	570	810	
		L2	570	570	570	570	570	570	810	1050	
		L3	810	810	810	810	810	810	810	810	1050
		B	770	890	1090	1090	1390	1390	1720	1720	
		H	770	890	770	1090	1090	1390	1390	1720	
<b>Electric heater</b>		L	570	570	570	570	570	570	-	-	
		B	770	890	1090	1090	1390	1390	-	-	
		H	770	890	770	1090	1090	1390	-	-	
<b>Sound attenuator:</b> Typ 1, Typ 2, Typ 3, Typ 4, Typ 5		L1	1050	1050	1050	1050	1050	1050	1050	1050	
		L2	1290	1290	1290	1290	1290	1290	1290	1290	
		L3	1530	1530	1530	1530	1530	1530	1530	1530	
		L4	1770	1770	1770	1770	1770	1770	1770	1770	
		L5	2010	2010	2010	2010	2010	2010	2010	2010	
<b>Crossflow heat exchanger <sup>1)</sup></b>		L	1290	1770	1290	1770	2010	2490	2490	3255	
		B	770	890	1090	1090	1390	1390	1720	1720	
		H	1540	1780	1540	2180	2180	2780	2780	3440	
<b>Crossflow heat exchanger <sup>2)</sup></b>		L	1290	1770	1770	1770	2010	2490	2490	3255	
		B	1540	1780	2180	2180	2780	2780	3440	3440	
		H	770	890	770	1090	1090	1390	1390	1720	
<b>Rotary heat exchanger</b> L1 = without flow metering unit L2 = including flow metering unit		L1	810	810	810	810	810	810	810	810	
		L2	1530	1530	1530	1530	1530	1530	1530	1530	
		B	1050	1290	1290	1530	1680	1980	2010	2490	
		H	1540	1780	1540	2180	2180	2780	2780	3440	
<b>Heat pipe</b> 4 - 8 RR including droplet eliminator		L	810	810	810	810	810	810	810	1050	
		B	770	890	1090	1090	1390	1390	1720	1720	
		H	1540	1780	1540	2180	2180	2780	2780	3440	
<b>Mixing unit</b>		L	570	570	570	570	810	810	810	810	
		B	770	890	1090	1090	1390	1390	1720	1720	
		H	770	890	770	1090	1090	1390	1390	1720	
<b>Frost protection frame</b>		L	330	330	330	330	330	330	330	330	
		B	770	890	1090	1090	1390	1390	1720	1720	
		H	770	890	770	1090	1090	1390	1390	1720	

T60 - Module dimensions of the components [mm]									
Module	Symbol	dimens.	20R	20Q	22R	22Q	25R	25Q	28R
<b>Heater</b> L1 = 1 - 3 RR L2 = 4 - 6 RR L3 = 8 RR		L1	330	525	-	-	-	-	-
		L2	570	525	525	525	525	525	525
		L3	570	525	-	-	-	-	-
		B	2020	2020	2260	2260	2570	2570	2870
		H	1720	2020	2020	2260	2260	2570	2570
<b>Cooler</b> L1 = 1 - 3 RR L2 = 4 - 6 RR L3 = 8 RR		L1	1050	1005	-	-	-	-	-
		L2	1050	1005	1005	1005	1005	1005	1005
		L3	1050	1005	-	-	-	-	-
		B	2020	2020	2260	2260	2570	2570	2870
		H	1720	2020	2020	2260	2260	2570	2570
<b>Evaporator</b> L1 = 1 - 3 RR L2 = 4 - 6 RR L3 = 8 RR		L1	1050	1005	1005	1005	1005	1005	1005
		L2	1050	1005	1005	1005	1005	1005	1005
		L3	1050	1005	1005	1005	1005	1005	1005
		B	2020	1980	2220	2220	2530	2530	2830
		H	1720	1980	1980	2220	2220	2530	2530
<b>Electric heater</b>		L	-	-	-	-	-	-	-
		B	-	-	-	-	-	-	-
		H	-	-	-	-	-	-	-
<b>Sound attenuator:</b> Typ 1, Typ 2, Typ 3, Typ 4, Typ 5		L1	1050	1245	1245	1245	1245	1245	1245
		L2	1290	1485	1485	1485	1485	1485	1485
		L3	1530	1725	1725	1725	1725	1725	1725
		L4	1770	1965	1965	1965	1965	1965	1965
		L5	2010	2205	2205	2205	2205	2205	2205
<b>Crossflow heat exchanger <sup>1)</sup></b>		L	3255	3255	3255	-	-	-	-
		B	2020	1980	2220	-	-	-	-
		H	3440	4040	4040	-	-	-	-
<b>Crossflow heat exchanger <sup>2)</sup></b>		L	3255	3255	3255	-	-	-	-
		B	4040	4040	4520	-	-	-	-
		H	1720	2020	2020	-	-	-	-
<b>Rotary heat exchanger</b> L1 = without flow metering unit L2 = including flow metering unit		L1	810	765	765	765	765	765	765
		L2	1530	1485	1725	1725	1965	1965	1965
		B	2490	2730	2970	3210	3450	3690	3690
		H	3440	3960	3960	4440	4440	5060	5060
<b>Heat pipe</b> 4 - 8 RR including droplet eliminator		L	1050	1050	1005	-	-	-	-
		B	2020	1980	2220	-	-	-	-
		H	3440	3960	3960	-	-	-	-
<b>Mixing unit</b>		L	1050	1050	1005	1005	1245	1245	1245
		B	2020	2020	2260	2260	2570	2570	2870
		H	1720	2020	2020	2260	2260	2570	2570
<b>Frost protection frame</b>		L	330	285	330	-	-	-	-
		B	2020	2020	2260	-	-	-	-
		H	1720	2020	2020	-	-	-	-

1) Dimensions arrangement one upon the other

2) Dimensions arrangement side by side

3) for filter service on dusty air side (VDI 6022) an additional service module is necessary. Alternatively Rosenberg terminal strip system is possible.

## Connection dimensions Airbox T60 - standard units (rectangular / quadratic):

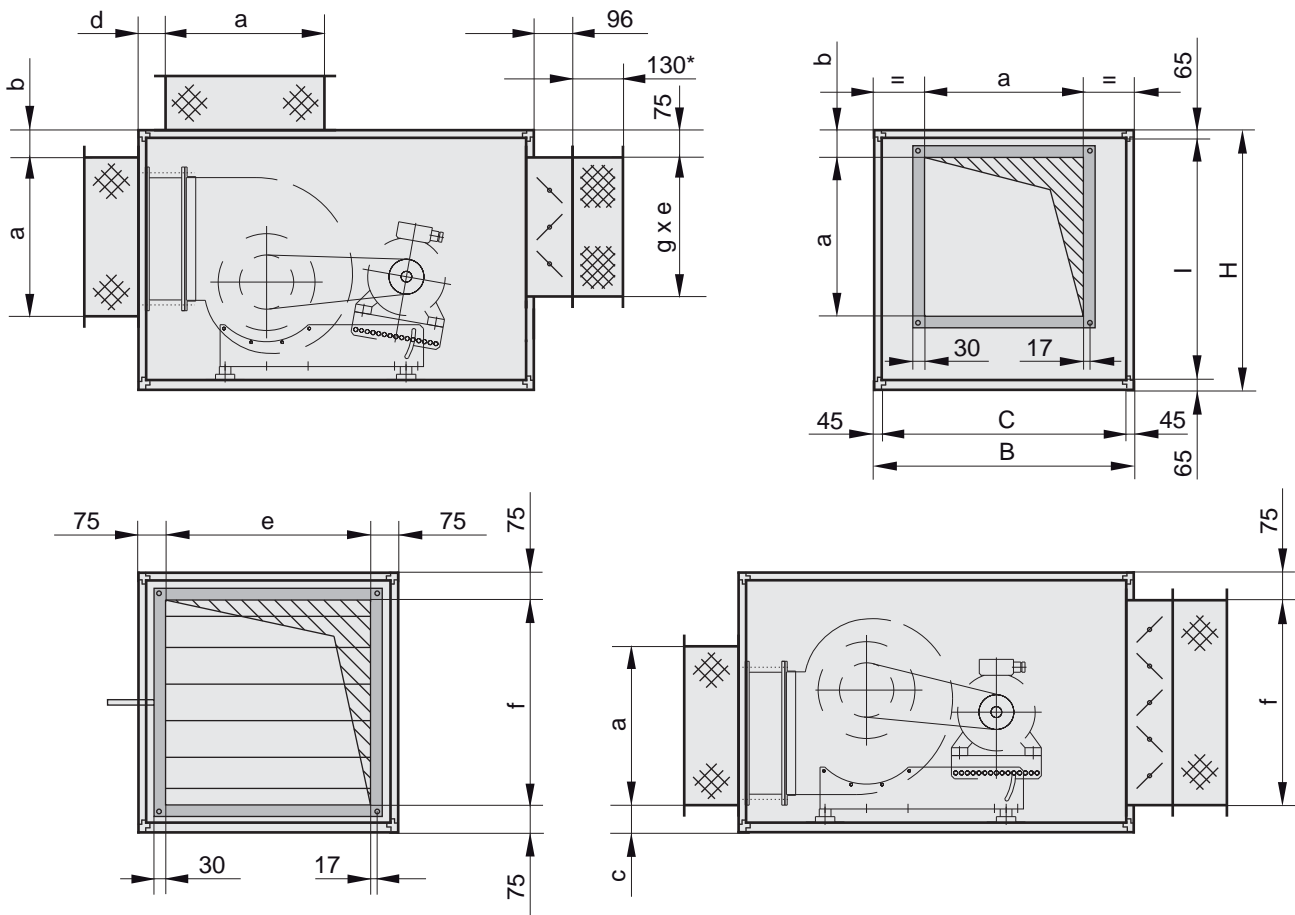

\* Installation length 130mm, total length 140mm / all dimensions in mm

Size	B	C	H	I	a	b	c	d	e	f	g
T60-07Q	770	640	770	640	410	120	120	120	620	620	375
T60-08Q	890	760	890	760	500	120	120	120	740	740	375
T60-10R	1090	960	770	640	500	120	120	120	940	620	375
T60-10Q	1090	960	1090	960	580	120/220	220/120	120	940	940	375
T60-13R	1390	1260	1090	960	700	120	120	120	1240	940	615
T60-13Q	1390	1260	1390	1260	700	170/270	270	120	1240	1240	615
T60-16R	1720	1590	1390	1260	900	120	120	120	1570	1240	615
T60-16Q	1720	1590	1720	1590	900	270	270	140	1570	1570	615
T60-20R	2020	1890	1720	1590	1000	270	270	140	1870	1570	855
T60-20Q	2020	1890	2020	1890	1000	420/270	290/305	140	1870	1870	855
T60-22R	2260	2130	2020	1890	1000	)	)	140	2110	1870	855
T60-22Q	2260	2130	2260	2130	)	)	)	140	2110	2110	855
T60-25R	2570	2440	2260	2130	)	)	)	140	2420	2110	1095
T60-25Q	2570	2440	2570	2440	)	)	)	140	2420	2420	1095
T60-28R	2870	2740	2570	2440	)	)	)	140	2720	2420	1095

) depends on the type of fan and the casing position



Reference object: Trumpf Maschinen Austria GmbH, Pasching (Austria)  
6 AHU's with air volumes from 5.000 - 30.000 m<sup>3</sup>/h



**Air handling units in outdoor design**

Every converted room inside buildings is very valuable. In buildings with flat roofs, it is also possible to set up an air handling unit on the roof in order to create surfaces which can be used for other purposes. If the air handling unit is not installed in a special ventilation station built on the roof to protect it against the elements, then the unit itself must be protected by its special outdoor design. The variant of unit installation which is most suitable depends on many factors, and must be decided on a case-by-case basis during planning. The properties of a weatherproof unit are described below.

In order to protect the unit against precipitation, weatherproof units are always equipped with an additional roof. In the standard version, the roof is a flat roof made from galvanized and strip-coated steel sheet in RAL 7035 colour with a roof excess length of 100 mm. In order to prevent transport damage, it is supplied loose together with all associated installation materials. The roof must be attached to the unit on the client’s premises using the façade screws. Depending on the unit size, the cover may comprise several parts. The sheets of the cover profiles are edged upwards at the individual joints. The joints are stuck over with butyl tape and covered with stainless steel rails in order to seal them. This provides a sealed covering surface all over the unit. Alternatively, the flat roof is also available as a variant made from simple galvanised steel sheet or as a configuration which can be coated subsequently in any RAL colour. For large units from size 16Q onwards, we also offer an alternative roof made from galvanised trapezoidal sheet panels which are strip-coated in RAL 7035.

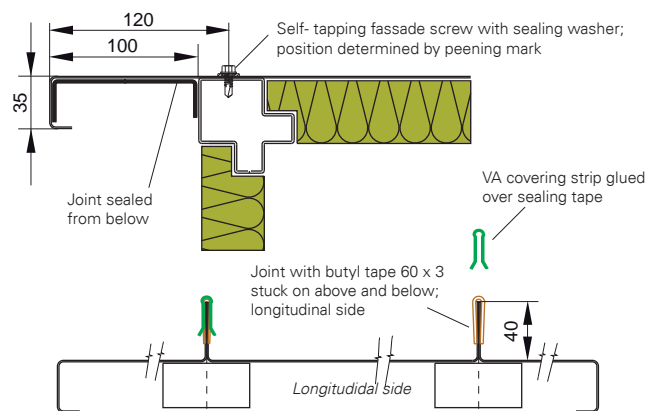

The unit casing itself, like the units for indoor installation, can in principle also be supplied in all available material variants. For increased corrosion protection, we recommend that the outside skin of the unit should at least be RAL 7035 strip-coated galvanised sheet steel, and that the coating of the unit frame should be in the same colour in the case of the Airbox F40 / S40 / S60 / I60 series.

As a rule, galvanised sheet steel is adequate for the inner skin of the unit. In the suction chamber for the outside air, however, it is recommended for additional coating to be applied due to the possibility of humidity entering with the air flow.

There are several possibilities for the unit termination at the bottom. Firstly, the unit can be placed on a pedestal made of steel or another construction material, meaning that it does not make any contact with the watertight layer of the flat roof. In many cases, it is possible to integrate the unit into the roof skin. We offer an all-round drip edge for this purpose, which can be attached to the base frame or, if the unit will not have a base frame, directly onto the bottom edge profile of the unit. In this way, water coming from above is transported past the connection of the roof seal against the unit base frame or pedestal, under the unit.

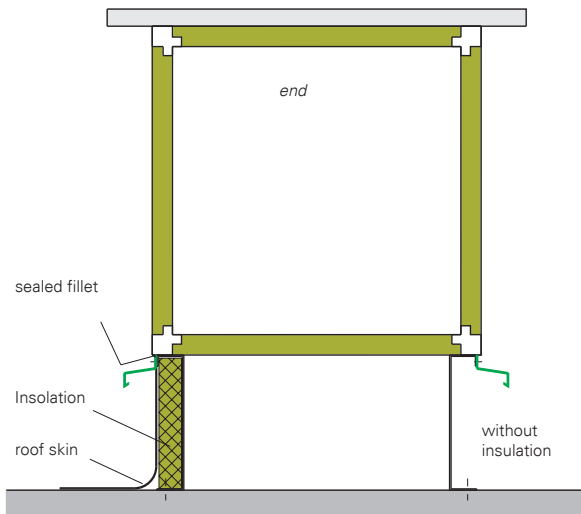

In addition, we equip outdoor units with some special accessories. In order to prevent precipitation entering the outside air opening and the exhaust air opening, we offer aerodynamically designed hoods and weather-resistant louvers. Additionally adding a droplet trap to the outside air suction opening enables the unit to be protected against the ingress of humidity as well.

Drives and sensors are fitted inside the unit, if at all possible. Nevertheless, components that have to be fitted on the outside of the unit such as unit switches are provided with a small canopy in order to provide them with additional protection against water, snow and ice, whilst still ensuring they can be operated at any time. All external plastic parts are UV-resistant.





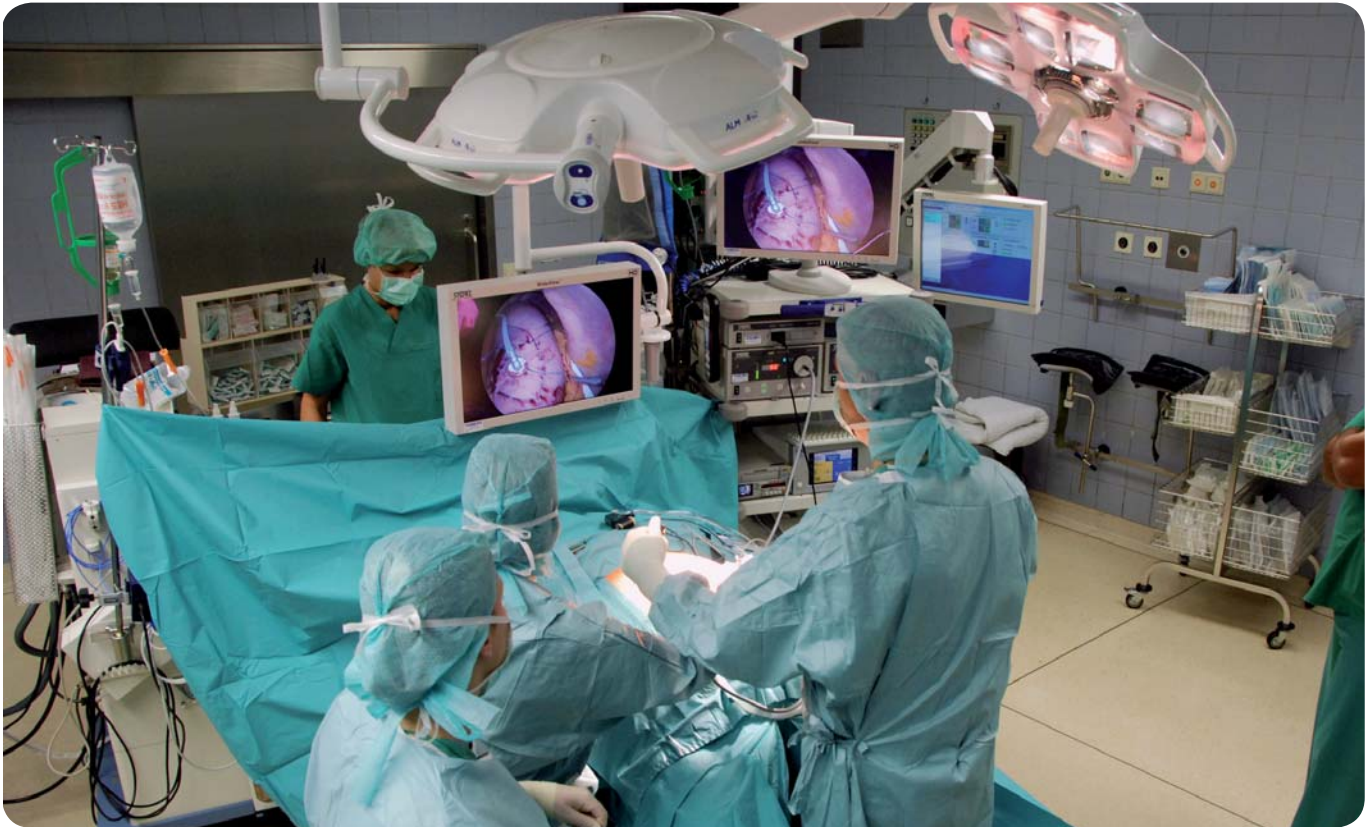

## Hygiene requirements on the unit casing

- The surface design must not be favourable for dirt build-ups
- The materials used must be resistant to disinfecting agents and abrasion
- Side walls and all components in the air flow must be minimum hot-dip galvanised and coated
- Base and slide rails that come into contact with condensation made from stainless steel or aluminium
- Seals with closed pores
- All permanently installed components must be accessible via doors or removeable panels
- All components must be protected against contamination and damage during the construction period
- Only condensation trays with a slope in all directions are allowed to be used
- Inspection windows and lighting are required in the filter and fan unit

## Hygiene requirements on the filters

- 2 or 3-stage filtering depending on the room category
- Filter change only permitted on the dusty air side
- Where filters have an anti-bacterial coating, proof of effectiveness and toxic safety is required
- Filter pressure drop meter without barrier fluid
- Only sealing profiles with closed pores are allowed to be used

## Hygiene requirements on heat exchangers

- Heater frame made from stainless steel (AISI 304) or aluminium (AlMg), fins are coated, or from aluminium (AlMg) or copper, headers made from copper
- Cooler frame made from stainless steel (AISI 304) or aluminium (AlMg), fins are coated or aluminium (AlMg) or copper, headers made from copper
- Cleaning must be possible for all parts in the wet area
- All condensation connections to be located on the same side
- It must be possible to inspect the cooling coil from both sides
- Cooler fin spacing at least 2.5 mm

## Hygiene requirements on the heat recovery unit

- Surface finish of the rotor or plate-type exchanger: Galvanised and coated frame, fins with epoxy resin coating or aluminium
- Condensate tray on the supply air and extract air side made from stainless steel
- Heat recovery systems should be placed on the outdoor air side downstream on the first filter stage
- In rooms where no cross-rooms air circulation is permitted only such systems are permitted that will not allow the transfer of particles from from the extract air to the supply air.

***Rosenberg air handling units in hygiene design acc. to DIN 1946/4 meet these requirements!***



# ZERTIFIKAT

## Genehmigung zur Nutzung des Prüfzeichens FREIWILLIGE PRÜFUNG DER HYGIENEANFORDERUNGEN GEPRÜFTE HYGIENESICHERHEIT VON LÜFTUNGSZENTRALGERÄTEN

Die

**TÜV NORD Systems GmbH & Co. KG, Hamburg,**  
bestätigt, dass die RLT-Geräte in Hygieneausführung der Baureihen

**„Airbox T60“ und „Airbox S60“**

die von der TÜV NORD Systems GmbH & Co. KG gestellten Anforderungen erfüllen.

Der

**Rosenberg Ventilatoren GmbH, Künzelsau-Gaisbach,**

wird daher das Recht verliehen, das nachstehend abgedruckte Prüfzeichen  
im Zusammenhang mit den o. g. Produkten zu führen.

TÜV NORD Systems GmbH & Co. KG  
Prüfstelle für Kälte-, Klima- und  
Lüftungstechnik

Dipl.-Ing. M. Klein

Essen, 21.11.2013



Die Gültigkeit des Zertifikates ist im Prüfzeichen-Nutzungsvertrag geregelt.



### Explosion-proof design

In series S40 and S60, we can supply air handling units with explosion protection acc. to ATEX 100, exclusively for above-ground application (unit group II) and for environments with potentially explosive gases. On request and following technical examination, it is also possible to produce units for dust EX.

In order to configure an explosion protected air handling unit acc. to ATEX, we require a „zone subdivision“ from the client which must contain the following information for the supply and/or exhaust air as well as the unit environment:

- Unit category, i.e. determining the frequency with which potentially explosive substances or substance mixtures occur during operation
- Temperature category, i.e. definition of the maximum permitted surface temperatures
- Explosion group of the gas which is present

There are 3 unit categories in unit group II:

#### Zone 0

A place in which an explosive atmosphere consisting of a mixture with air of flammable substances in the form of gas, vapour or mist is present continuously or for long periods or frequently. Safety must also be guaranteed in the event of rare unit malfunctions (very high level of safety).

#### Zone 1 (category 2G)

A place in which an explosive atmosphere consisting of a mixture with air of flammable substances in the form of gas, vapour or mist is likely to occur in normal operation occasionally. The necessary safety must be guaranteed in the case of foreseeable malfunctions or fault statuses (high level of safety).

#### Zone 2 (category 3G)

A place in which an explosive atmosphere consisting of a mixture with air of flammable substances in the form of gas, vapour or mist is not likely to occur in normal operation but, if it does occur, will persist for a short period only. Safety must be guaranteed during normal (designated) operation (normal level of safety).

Rosenberg produces air handling units for zones 1 and 2, i.e. unit categories 2G and 3G. Theoretically, pressure-resistant encapsulation of the entire unit would be required for zone 0. This is technically and practically impossible; therefore we cannot offer any air conditioning units for zone 0

*Note for export of ex-proof air handling units:*

We are certified according to ATEX 100 and GOST R, which means we can offer air handling units in explosion-proof configuration (Airbox S40 and S60) for the Russian market.

The following table provides an overview of the existing temperature categories and allocated potentially explosive substances, as well as their explosion group.

Explosion group	Temperature classes and the maximum surface					
	T1 (450°C)	T2 (300°C)	T3 (200°C)	T4 (135°C)	T5 (100°C)	T6 (85°C)
I IA	Acetone Ammonia Benzol (pure) Ethane Acetic acid Ethyl acetate Ethyl chloride Carbon monoxide Methane Methanol Chloromethane Naphtalin Phenol Propane Toluene	Cyclohexanone i-Amyl acetate n-Butane n-Butyl alcohol	Benzine Diesel fuel Aircraft fuel heating oil n-Hexane	Acetylaldehyde		
I IB	Citygas (coal gas)	Ethylene	Hydrogen sulphide Ethylglykol	Ethyl ether		
I IC	Hydrogen	Acetylene				Carbon disulphide

- Available
- Temperature category T4 and applications with hydrogen on request
- Use of an air handling unit not possible as a rule

For more information about technical regulations governing explosion-proof air handling units, please refer to Guideline RLT 02 of the German AHU Manufacturers Association. This guideline is available for free as a pdf file from the association's website at [www.rlt-geraete.de](http://www.rlt-geraete.de).

**Information about zone allocation of an air handling unit**

Due to possible leakages between the air profiles as well as between the unit casing and the environment, the zones between the air sections are only allowed to differ by one zone; this also applies between the inside and outside of the unit. All components in the ex-area must be arranged on the suction side of the fan (no pressure drop between the ex-areas and non-ex-areas). Recirculated air is not permitted in any cases if there are different zones in the supply and exhaust air. Important in case of different zones in the outside air and exhaust air: Make sure there is a sufficient distance between the exhaust air outlet and the outside air inlet!

**Usance zone classification for units with heat recovery**

Supply air in the unit	Exhaust air in the unit	Environment	Possible heat recovery	Possible unit design
<b>Outdoor installation</b>				
not Ex	Zone 2	not Ex	PHE, RAC, Heat pipe	Combined unit possible, recirculating air forbidden
<b>Indoor installation</b>				
not Ex	Zone 2	Zone 2	PHE, RAC, Heat pipe	Combined unit possible, recirculating air forbidden
Zone 2	Zone 1	Zone 2	PHE, RAC, Heat pipe	Combined unit possible, recirculating air forbidden
Zone 2	Zone 2	Zone 1	PHE, RAC, Heat pipe, RHE	Combined unit possible, recirculating air allowed
Zone 1	Zone 1	Zone 2	PHE, RAC, Heat pipe, RHE	Combined unit possible, recirculating air allowed
<b>Separate installation</b>				
not Ex	Zone 1	Supply air unit: Zone 2 Exhaust air unit: Zone 1 or 2	RAC	Indoor unit in separate rooms Only separate supply - and exhaust air units possible
not Ex	Zone 1	Supply air unit: not Ex Exhaust air unit: Zone 1 or 2	RAC	Assembly inside/outside in separate areas

*Note: This does not necessarily cover all of the possible situations*

**Special features of ex-proof air handling units acc. to ATEX**

The design of an explosion-proof air handling unit must be adapted to the particular application. Two sample details

of material pairings and electric conductivity are presented below:



*Example 1)*  
Sources of ignition must be avoided at the fan. Therefore, this is configured in the material pairing of steel/copper on the impeller and nozzle, and equipped with an explosion-proof motor.



*Example 2)*  
To provide a safe, electrically conductive connection, the parts such as here the door (left) are additionally connected to the unit casing (right) by an earth cable.



## Saving energy and costs

Use of heat recovery systems (HRU) has become essential since the enormous increase in energy prices over the past few years, if not before. In accordance with the legal requirement of the German Energy Saving Ordinance (EnEV), room ventilation devices with a supply air flow rate of more than 4000 m<sup>3</sup>/h must be equipped with a heat recovery unit.

Depending on the system used, the amount of energy required annually for heating or cooling can be reduced by up to 90% compared to a system without heat recovery. A heat recovery system also allows the heater or cooler used to be made smaller, resulting in a significant reduction in investment costs in the conventional technology area. In most cases, it is true, using a heat recovery unit does increase the investment costs for the system, whereas the lifecycle costs are cut at the same time. As a result, the economic efficiency is increased.

A heat recovery system takes heat from the extract air and supplies it to the outside air as recovered heat. At the same time, it is possible to use various heat recovery systems depending on the design of the room ventilation system and/or the requirement for air quality.

Heat recovery units are divided into 3 categories according to VDI 2071: Recuperators, regenerators with fixed separating surfaces and regenerators with contact surfaces.

In recuperators, heat is exchanged between two air flows with different temperature via separating surfaces. The air flows are combined in one casing (e.g. plate heat exchanger)

In the regenerator, the extract air transfers its heat to a heat storage medium. This medium then transfers the heat to an air flow (outside air) supplied to the system.

As far as regenerators are concerned, they are divided into heat recovery units with fixed separating surfaces (e.g. heat pipe, run around coil system) in which the heat is transferred to a liquid or gaseous heat carrier, and heat recovery units with contact surfaces (e.g. rotary heat exchanger). In these units, the heat is transferred by a rotating, solid storage mass.

**Higher efficiency**  
**Lower lifecycle costs**

**Lower environmental pollution**  
**Reduced energy requirement**

**Lower operating costs**  
**Reduction in the heating/cooling power required**



## Plate heat exchangers

Plate heat exchangers (PHEs) are used as recuperative thermal transmittance units in cross or counterflow. The most frequently encountered and lowest-cost variant is a cross-flow plate heat exchanger. Depending on the selected size, it achieves a dry efficiency of approx. 65% at most. However, the efficiency can rise to more than 70% in operation with increasing humidity of the waste air as well as increasingly cold outside air and the associated increase in condensation formation on the extract air side of the plate heat exchanger.

Cross-flow plate heat exchangers are manufactured from seawater-resistant aluminium plates which have profiles optimised for thermal transmittance, and are grouped together into a block by means of an aluminium/zinc frame. The plates are pressed with a double fold at their open ends, resulting in alternate flow pathways offset at right angles for both air flows. With a maximum leakage of 0.1%, these heat exchangers are practically sealed and are therefore particularly suitable for applications involving extract air polluted with an odour.

For hygiene applications or if increased corrosion protection is required, the plate heat exchanger can be ordered with plates that have an additional epoxy resin coating and a powder-coated frame. At extra cost, almost 100% sealing of the plate heat exchanger with subsequent leak test is available as an option in applications involving aggressive waste air, for example. Plate heat exchangers are silicone-free as standard and can be used at up to 90 °C, although variants with silicone

seals are available for temperatures up to 200 °C. Dry efficiency levels of about 80% can be achieved by connecting 2 cross-flow plate heat exchangers in series to form a double plate exchanger with cross/counterflow thermal transmittance. Indeed, upwards of 90% can be achieved with the condensation of humidity in the extract air. However, this variant involves an increased length.

Special cross/counterflow plate heat exchangers, a variant of the cross-flow plate heat exchanger, are suitable for small air flows up to approx. 3000 m<sup>3</sup>/h. As with the double plate exchanger, efficiencies of more than 80% can be achieved with dry air or more than 90% with moist air, combined with a compact length. Due to being optimised for efficiency and pressure loss, these heat exchangers are significantly more delicate than cross-flow plate heat exchangers, which means they are no longer suitable for high pressure differentials.

It is possible to control the power of the plate heat exchanger by installing a bypass damper in the unit. The condensation which builds up in many operating statuses must be removed by means of condensate trays in the unit and siphons. Ice can form in the plate heat exchanger during winter when condensation builds up. Depending on the type and arrangement of the plate heat exchanger, different variants are possible for de-icing or avoiding icing; uneven air volumes, bypass, pre-heating. The control strategy, and the components and power levels required for the selected variant, must be matched to one another and to the local conditions.

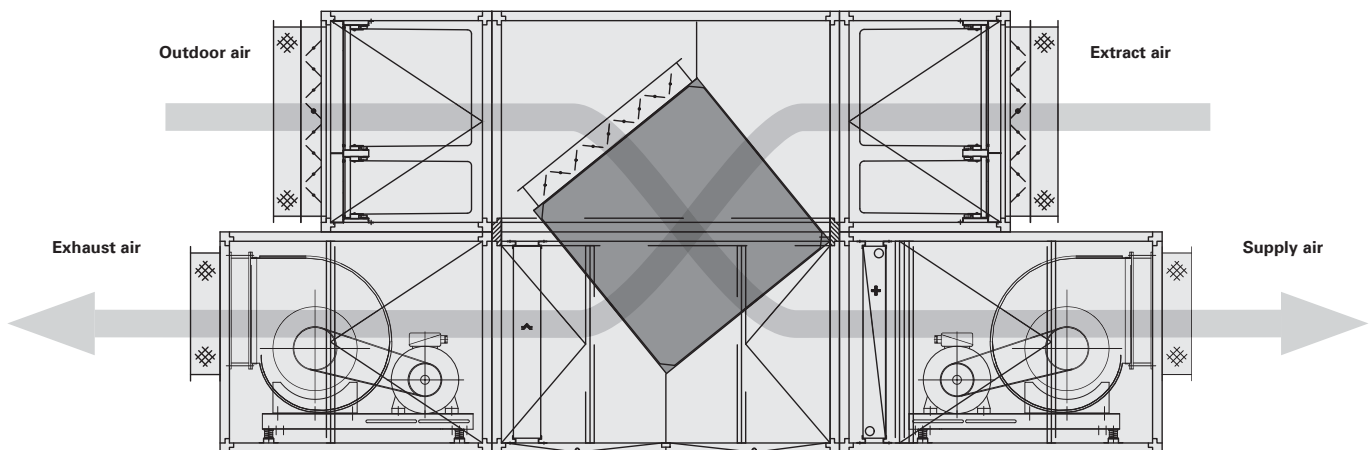

## Rotary heat exchangers

Rotary heat exchangers (RHEs) are part of the regenerative heat recovery group, and consist of a slowly rotating storage mass located in the counterflow of the supply and extract air. Considering a small profile of the rotary heat exchanger in winter operation, it can be seen that it absorbs heat from the extract air flow as it rotates and, as the rotation continues, it outputs the heat to the supply air flow in alternation. If the rotary heat exchanger is large enough, it is possible to

achieve dry heat recovery indexes in excess of 80% combined with low pressure losses and a short length. A rotary heat exchanger offers the additional benefit that different levels of humidity can be transferred in addition to the heat recovery, depending on the version. In the classic condensation rotary heat exchanger with a storage mass comprising corrugated aluminium foil, part of the extract air humidity is transferred to the supply air during periods of low outdoor temperatures in

winter when there is condensation. This can prevent excessively dry room air in offices during winter, for example.

In a rotary heat exchanger with additional hygroscopic coating (enthalpy rotary heat exchanger), there is a transfer of humidity throughout the year. This makes it possible to save the power otherwise required for humidification in systems with humidification and cooling in winter, while in summer the dehumidification of the outside air before the cooler also saves cooling power. In addition to this, special sorption rotary heat exchangers offer the highest humidity transfer throughout the year. They are suitable above all for what is referred to as sorption-based air conditioning.

The power of the rotary heat exchanger is controlled by changing the rotor speed. In central European conditions, there is no need to provide a device for icing protection.

The rotor is sealed against the casing by felt or plastic seals. However, complete sealing is impossible, which is why the rotary heat exchanger is particularly suitable for applications in which recirculating air is permitted, unless further precautions are taken. Use of a double purge sector, selection of a suitable arrangement of the fans for the rotary heat exchanger and consideration of the pressure conditions resulting at the rotary heat exchanger make it possible for the leakages to be completely channelled from the outside air to the exhaust air. As a result, given correct planning, configuration and operation, a rotary heat exchanger with hygroscopic coating can even be suitable for applications in the health system acc. to DIN 1946-P4

From rotor diameters of 2.6 m onwards, the rotary heat exchanger is delivered to the construction site in segments and must be assembled on site

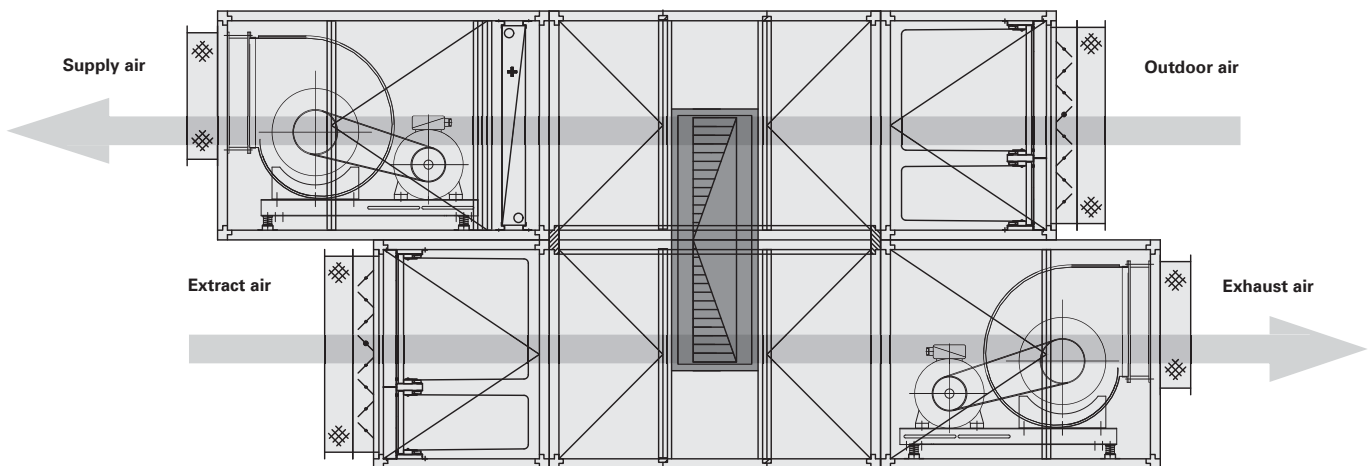

### Run around coil system

Run around coil systems are regenerative systems. A frost-protected water/glycol mixture is used as the heat carrier.

A run around coil system (CCS) consists of 2 coils, one in the supply air and one in the extract air. Both coils are connected by a piping system with pump, control valve, expansion vessel, etc.

In winter conditions, the extract air coil acts as a cooler. The water/glycol mixture in the circuit absorbs heat from the extract air and transports it to the supply air coil, which then acts as a heater. In summer conditions, the function of both coils is inverted. In particular in winter with cold outside temperatures, condensation can build up at the extract air register and has to be removed by means of a condensate tray and a siphon. Depending on the air velocity in the unit, it can be necessary to install a droplet eliminator after the extract air register in addition, in order to prevent condensation droplets being carried along in the air flow. Under favourable conditions, a run around coil system can achieve a dry heat recovery index of

up to 70%. The power is controlled by varying the position of the control valve.

Run around coil systems are particularly suitable for applications in potentially explosive areas as well as for all cases in which the supply air and extract air cannot or are not allowed to be combined in the same unit. Also, there can be advantages in the renovation of existing ventilation systems.

The circuit of the run around coil system can be expanded in addition, for example to incorporate additional heat or to shed cold, however as a rule this has a negative effect on the efficiency of the system. The additional components in the circuit and the systems that have to be linked to them must be configured for the specific application and adapted to one another. As a result, such relatively complex systems can only be delivered following a detailed enquiry. It should be mentioned as an advantage that it is possible for a reheater to be avoided.

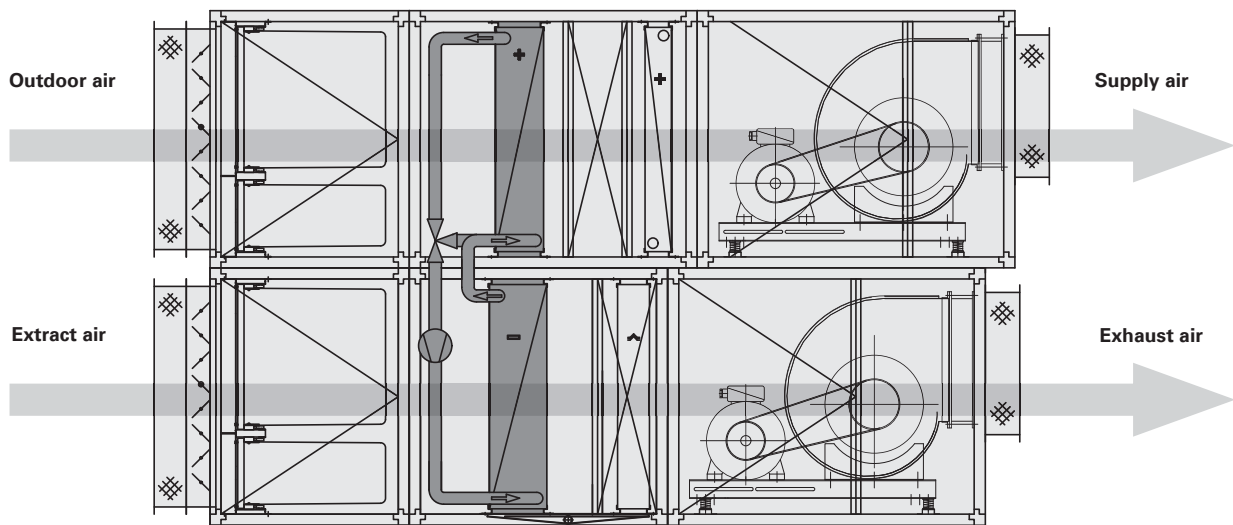

### Heat pipe

A further regenerative system is the so-called heat pipe. This is actually a register with several separate pipes filled with refrigerant. Refrigerant evaporates at one end of the pipe and absorbs heat, then flows to the other end by convection where it condenses and gives off its heat again. As a rule, the attainable heat recovery indexes are lower than in the heat recovery unit designs referred to above.

The design of the heat pipe means that only certain arrangements are possible in the air handling unit:

- The pipes of the heat pipe register are arranged vertically if the supply air and exhaust air lines are arranged one upon the other. The supply air must be at the top in this case.
- If the supply and exhaust air lines are arranged side by side, the heat pipe is installed tilted towards the exhaust air side

In both these cases, the thermal transmittance in the heat pipe only takes place in one direction, i.e. the heat pipe can only be operated for heating. The power is controlled by means of a bypass.

As a result of the system-related requirements specified, the heat pipe is of rather lower significance than the aforementioned heat recovery units. It is necessary to examine on a case-by-case basis whether it makes sense to use a heat pipe.

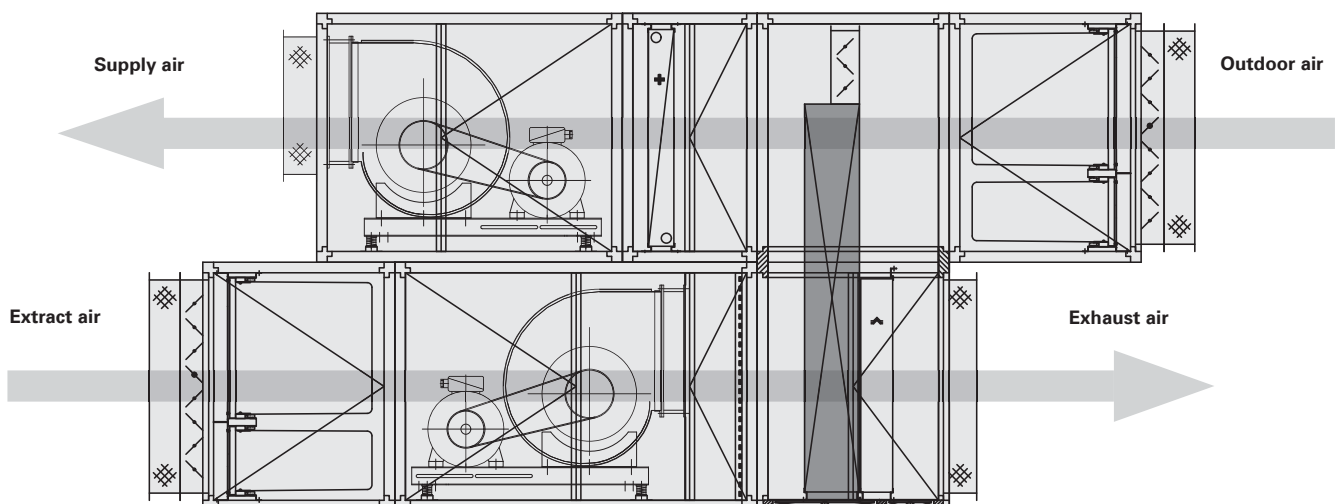



## Comparison between heat recovery types:

	Plate heat exchanger (PHE)	Rotary heat exchanger (RHE)	Run around coil system (CCS)	Heat pipe
<b>Achievable dry heat recovery index under favourable conditions</b>	< 65% crossflow-PHE  > 80% twin-PHE and counterflow-PHE	> 80%	< 70%	< 65%
<b>Humidity transfer</b>	no	low with condensation rotor higher with hygroscopic rotor maximum with sorbtion rotor	no	no
<b>Supply and exhaust air must be brought together</b>	no	no	no	yes
<b>Length</b>	medium to large	low	low	low
<b>Leakage</b>	low / no	The direction is dependent on the version	no	without if fixed
<b>Frost-protection required</b>	yes	no	yes	yes
<b>Condensation drain required</b>	supply - and exhaust side	no	exhaust side	exhaust side
<b>DIN 1946 T4</b>	yes	Only enthalpy or sorption rotary heat exchangers, and if the leakage is directed from supply air to exhaust air	yes	yes
<b>Exhaust air polluted with odour</b>	yes	no	yes	yes
<b>Exhaust air from kitchen</b>	yes	no	yes	yes
<b>Explosion protection acc. to ATEX</b>	yes	Only if recirculating air is permitted	yes	yes
<b>Moving parts required for operation and maintenance</b>	no	yes	yes	no
<b>Specific costs (ca.) in EUR per m<sup>3</sup>/h</b>	up to 0,65	up to 0,90	up to 1,40	up to 1,20
<b>Remarks</b>	-	Self-cleaning effect, therefore particularly suitable for painting systems, etc	-	-



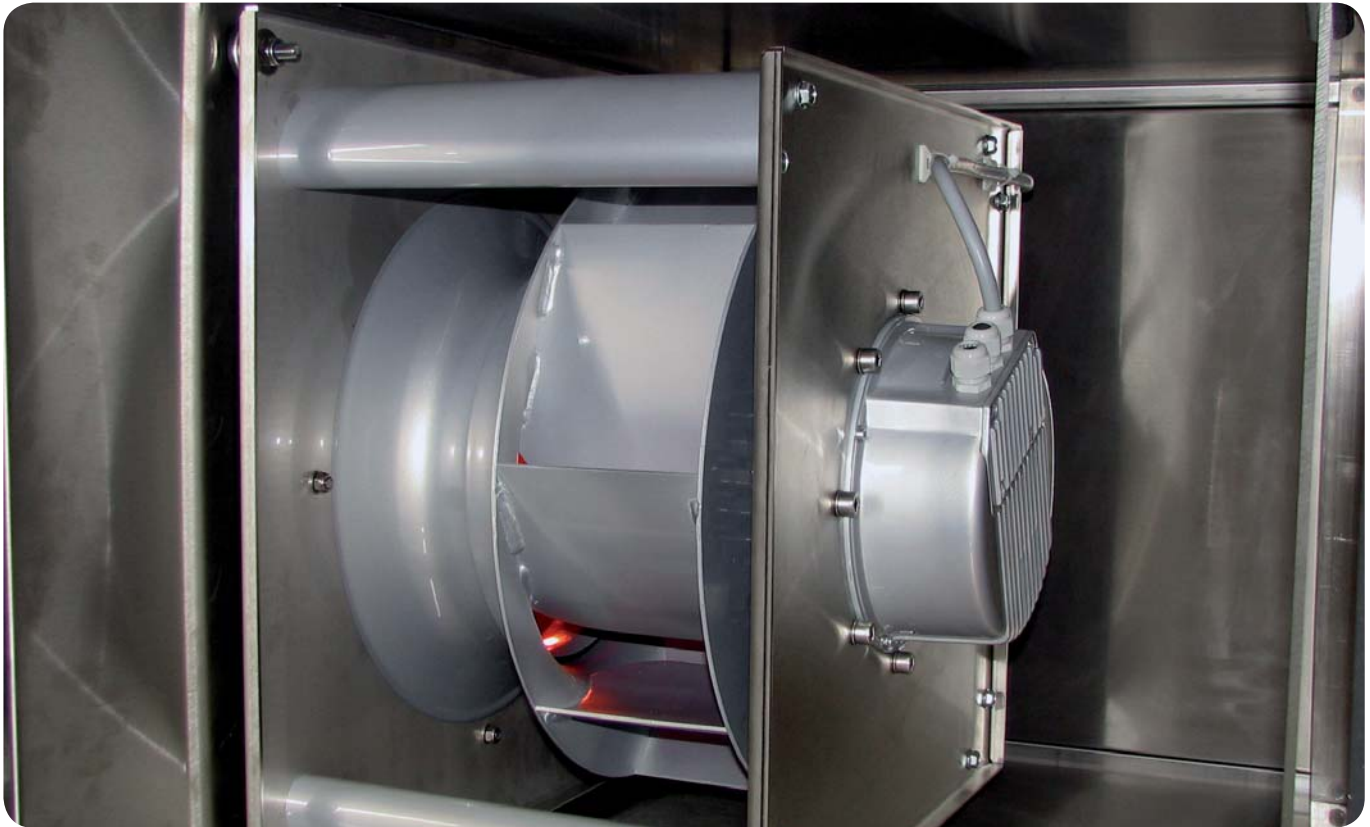

### Fans for air handling units

The following section presents the fan designs principally used in the air handling unit, and their advantages. For reasons of energy saving, fan types with backward-curved impellers have come to dominate the area of air handling units.

Free-running impellers with EC or AC external rotor motors are particularly characterised by their high power-to-weight ratio in conjunction with the compact drive concept. The motor/impeller combination is selected for optimum performance. Direct drive enables this fan type to be used in a wide variety of applications in accordance with hygiene requirements (DIN 1946, VDI 6022). EC motor technology is an innovative drive technology and enables operation at very high efficiency levels with even higher air handling capacity across the entire speed range of the fan.

Use of IEC standard motors as direct drive for the free-running impellers in the medium and large performance range delivers numerous advantages. IEC standard motors are standardised across the world, and are optimally adapted to the performance requirement of the impeller, meaning that the fan can be operated at a high level of efficiency and with a low energy requirement.

The classic fan driven by a V-belt or flat belt is available in all requirements areas. IEC standard motors are used as a drive on clamping slides. The wide variety of transmission ratios allows configurations of the fan at precisely the desired operating point, with 1, 2 or 3-stage standard motors. The clam-

ping slide design means the standard motor can be adjusted in parallel to the axis. As a result, it is a straightforward matter to re-tension the belt

In fans with IEC standard motors, high-quality motors from renowned manufacturers are used as standard. All motors with a shaft power of more than 2.2 kW are equipped with PTC resistors. The EC and AC external rotor motors used are from in-house production. Installing the motor in the fan impeller produces an economical and space-saving drive unit.



**Note:** The investment costs for EC fans may be slightly higher compared to conventional fans, but pay off within a very short operating period due to the lower energy consumption and reduced installation complexity (no transformer, frequency inverter or phase angle control unit required)



**Free-running impeller with EC external rotor motor**



**Economic application range:**

- Static pressure increases up to 1200 Pa
- Flow rates up to 12,000 m<sup>3</sup>/h
- Higher air handling capacities are also possible when several fans are operated in parallel

**Advantages:**

- Highly efficient EC motor with integrated control technology
- Very compact length
- It is possible to combine several fans in parallel making a „fan wall“, i.e. increasing the flow rate with a short length
- No frequency inverter used
- Direct drive, no power losses due to a belt drive
- No belt abrasion, therefore single-stage filtering is possible
- Very low maintenance

**Free-running impeller with IEC standard motor (IE2)**



**Economic application range:**

- Static pressure increases up to 1,500 Pa
- Flow rates up to 75,000 m<sup>3</sup>/h

**Advantages:**

- Infinitely variable setting of the operating point by means of frequency inverter
- Direct drive, no power losses due to a belt drive
- No belt drive, therefore single-stage filtering is possible
- Very low maintenance
- Easy to clean, therefore particularly suitable for units with increased hygiene requirements
- Can also be used for waste air from kitchens in conjunction with an encapsulated motor with external ventilation
- Can also be used in the upright unit as a module variant

**Belt driven fan with IEC standard motor (IE2)**



**Economic application range:**

- High static pressure increases > 1500 Pa
- High flow rates

**Advantages:**

- Simple and cost-effective one-time setting of an operating speed
- Cost-effective setting of two operating speeds by using a pole-changing IEC standard motor
- Infinitely variable operation possible in conjunction with a frequency inverter
- High pressure increases possible
- Minimisation of belt drive losses and dispensing with the subsequent filter stage possible by using a flat belt

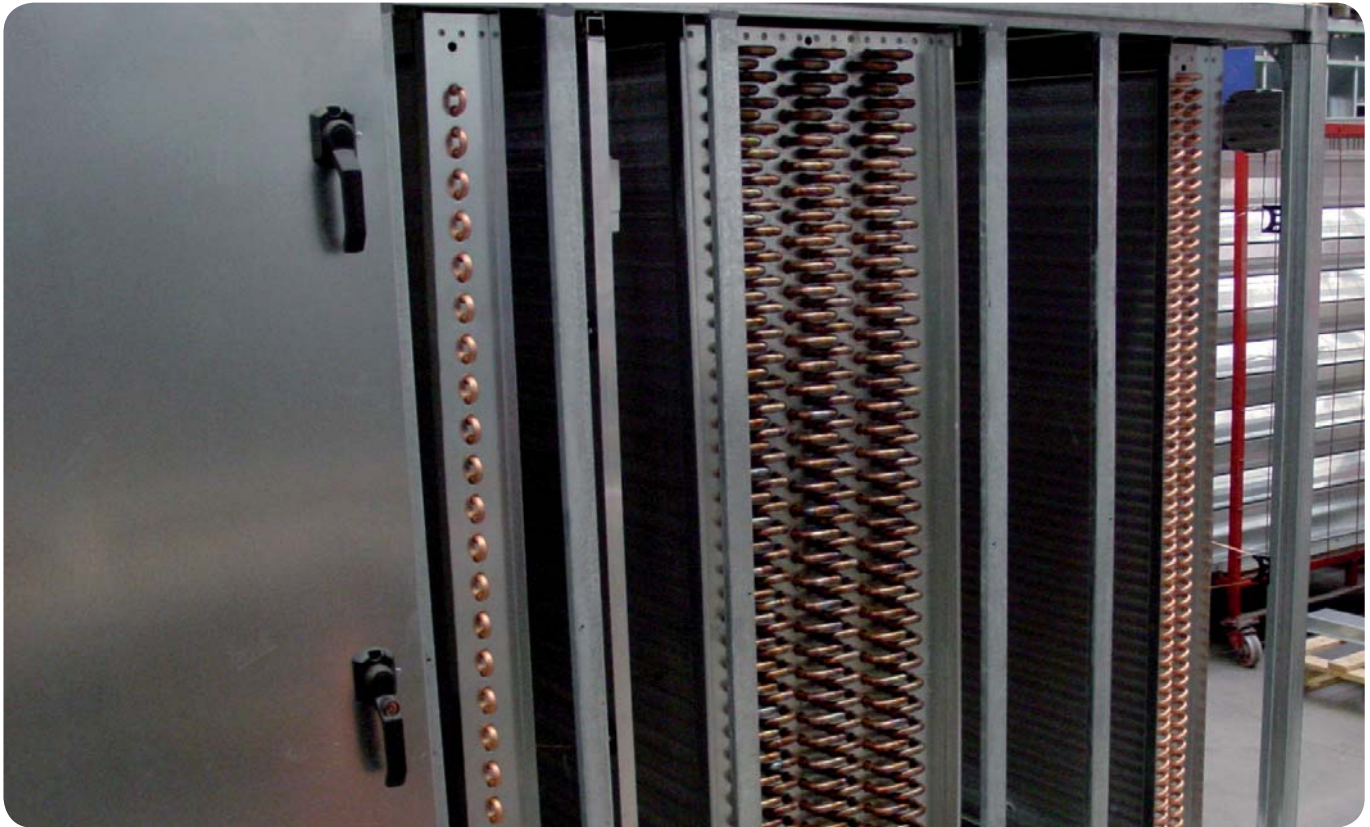

## Heat exchangers

Air temperature is very important for a pleasant climate. Therefore, air heaters and coolers play a significant role in room ventilation units. Chiefly, finned heat exchangers are used as heaters or coolers. The materials used in this case range from completely galvanised steel finned heat exchangers through to copper/aluminium (tube / fin) and stainless steel (tube and fin)

### Finned heat exchangers

Finned heat exchangers for heating/cooling media can be supplied in the following material pairings:

- Copper tube / aluminium fin (standard)
- Copper tube / aluminium fin with epoxy coating
- Copper tube / copper fin
- Stainless steel 1.4301 / aluminium fin
- Stainless steel 1.4301 / aluminium fin with epoxy coating
- Fully galvanised steel
- Smooth copper tube

Operating pressure: max. 16 bar (test pressure: 21-30 bar)  
 max. water temperature: 100 °C for standard heat exchangers in copper / aluminium version; with reinforced copper pipe, water temperature up to 160 °C is also possible

The frame and headers are configured in copper, galvanised steel, painted steel or stainless steel 1.4301, depending on the version.



*Note:* No standard heat exchanger in copper / aluminium can be used in conjunction with borehole water! In this case, a heat exchanger with stainless steel tubes must always be used.

Condensation trays of air coolers made from AlMg3 or stainless steel 1.4301 are available in two configurations:

- Top-mounted pan with 40 mm drain diameter
- Base pan with 32 mm drain diameter

Droplet separator comprising talc-reinforced polypropylene trap profiles (PPTV, able to withstand up to 100 °C on a continuous basis) in a frame cartridge made from aluminium with a handle recess on the end. Droplet separator cartridge separately mounted on stainless steel slide rails (1.4301) and extractable to the side via an access cover (droplet separator fins can be removed individually for cleaning). Direct connection of an optional siphon with return prevention and self-filling is possible.

### Coolers:

- Collectors in standard coolers from 4RR onwards made from copper
- Fin spacings in coolers and direct evaporators at least minimum 2.5 mm
- The extended casing length ensures access to the coil

### Heaters:

- Collectors in standard heaters up to 3RR made from steel / painted, above that made from copper
- Fin spacing in standard heaters minimum 2.1 mm
- Frost protection can be extracted via frost protection frame / empty part

*Note: The following reference values for water side pressure drop must be complied with when configuring heating or cooling registers (exclude run around coils):*

Heaters::  $\Delta p$  water min. 1,5 kPa ; max. 20 kPa  
 Coolers:  $\Delta p$  water min. 1,5 kPa ; max. 50 kPa

### Electric heating coils

The electric heating coils used are exclusively for heating dust-free air, and non-aggressive and non-inflammable gases. The heating elements are made from corrosion-resistant heating wire which is wound around ceramic, asbestos-free holders (acc. to DIN 40685) in the aluminium frame. A low surface temperature is achieved by using a bimetallic temperature limiter. The temperature limiter is connected so that the electrical power supply to the heating register is cut off when a temperature of 75 °C is reached on the upper casing surface. The switching power of the temperature limiter is 230 V / 10 A. The electrical connection is by way of a terminal strip with plastic cover. Further wiring must be made in accordance with VDE 0100 (at extra cost, the connection cable is routed to a

### Directly fired heating registers

Directly fired heating registers for installation in central ventilation stations, comprising: Combustion chamber made of chromium-alloyed, highly heat-resistant stainless steel 1.4541. Pipe bundle – heat exchanger made from alloyed stainless steel 1.4301 equipped with flue gas turbulators and condensation drain pipes. The inspection window and burner connection plate are mounted on the front, and there is provision for connecting oil and gas fan burners. The combustion chamber and heat exchanger operate in the threepass principle. The combustion chamber and heating register are bolted on using a flange connection as standard. The complete unit can thus be dismantled into two parts without difficulty. Cleaning is possible by means of inspection covers of adequate size for maintenance. These are mounted on the front deflection box above the burner. The exhaust gas pipe is arranged opposite the burner (at rear). Bypass operation is possible using a by-

### Design for weatherproof units:

- The casing is extended accordingly when internal pipe connections are used
- The heat exchanger is produced with angled connections for the interior piping

### Design for hygiene units:

- Headers of heaters made from copper
- Frames of coolers made from aluminium or stainless steel 1.4301

### Design for upright units (cooler):

- Fin spacings at least minimum 3.0 mm
- Droplet separator are always installed at an angle and underneath the cooler
- Air velocity max. 2.5 m/s
- Condensate tray



plastic terminal box located outside the unit). The connection of the overall electrical system must ensure that the electric heating coil is not operated without an air flow in motion. An additional safety temperature limiter with manual reset is installed.



pass damper. Sealing plates: a complete set of sealing and thermal insulation board (for 50 mm insulation thickness), burner connection plate incl. holes according to the customer's specification (state the burner type), inspection tube screw connection. Thermostats up to and including 600 kW power comprising a 3-way safety thermostat grouped in one casing (max. blow-out temperature 50 °C). Fan thermostat, flame monitor and a safety temperature limiter configured as a spiral sensor, TÜV-tested acc. to DIN 3440 and 4794. 2 items are used from 900 kW and upwards.

Heating media: Natural gas, liquefied gas, heating oil



**General information**















Legislation demands that the supply air delivered by the machine is of higher quality than the drawn-in outside air. In order for our room ventilation units to meet these requirements, Rosenberg uses a wide variety of matched filter types. In addition to the bag filters which are familiar, these include panel, Z-line, compact, wire mesh, activated carbon or HEPA filters. The

filter is very important for air hygiene, but can itself become a hygiene problem if not maintained and inspected correctly, as a result of which microbially safe filters are generally used.

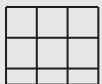
**Filter classification**

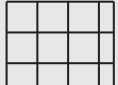
Classification in				Air filters
Separation efficiency	Efficiency	EN 779	DIN 24185	Examples and applications
99,8 %	> 95 %	F9	EU9	Hospitals, production facilities for pharmaceuticals, optical instruments or electronics; pre-filters for HEPA filters
99,5 %	95 %	F8	EU8	
99,3 %	90 %	F7	EU7	Offices, IT rooms, medical treatment rooms, radio and TV centres, laboratories
98 %	80 %	M6	EU6	Schools, department stores, workshops for precision machinery or as pre-filters for higher rated filters
95 %	40 %	M5	EU5	Industrial areas, protection of built-in parts in room ventilation systems
92 %	35 %	G4	EU4	For low requirements
80 %	20 %	G3	EU3	
65 %	10 %	G2	EU2	
65 %	10 %	G1	EU1	

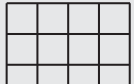
**Dimensions according to sizes**

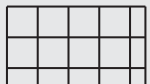
Frame size AIRBOX	Classification of the filters	External dimensions (ca.) in m	Filter classification in mm (B x H)	Air volume at 2.5 m/s in the unit face
<b>07Q</b>		0,7 x 0,7	1 pcs. 592 x 592	4.000 m <sup>3</sup> /h
<b>08Q</b>		0,85 x 0,85	1 pcs. 756 x 678	5.600 m <sup>3</sup> /h
<b>10R</b>		1,0 x 0,7	1 pcs. 592 x 592 1 pcs. 287 x 592	6.000 m <sup>3</sup> /h
<b>10Q</b>		1,0 x 1,0	1 pcs. 592 x 592 1 pcs. 592 x 287 1 pcs. 287 x 592 1 pcs. 287 x 287	9.000 m <sup>3</sup> /h
<b>13R</b>		1,3 x 1,0	2 pcs. 592 x 592 2 pcs. 592 x 287	12.000 m <sup>3</sup> /h
<b>13Q</b>		1,3 x 1,3	4 pcs. 592 x 592	16.000 m <sup>3</sup> /h
<b>16R</b>		1,6 x 1,3	4 pcs. 592 x 592 2 pcs. 287 x 592	20.000 m <sup>3</sup> /h
<b>16Q</b>		1,6 x 1,6	4 pcs. 592 x 592 2 pcs. 592 x 287 2 pcs. 287 x 592 1 pcs. 287 x 287	25.000 m <sup>3</sup> /h
<b>20R</b>		2,0 x 1,6	6 pcs. 592 x 592 3 pcs. 592 x 287	30.000 m <sup>3</sup> /h
<b>20Q</b>		2,0 x 2,0	9 pcs. 592 x 592	36.000 m <sup>3</sup> /h
<b>22R</b>		2,2 x 2,0	9 pcs. 592 x 592 3 pcs. 287 x 592	42.000 m <sup>3</sup> /h
<b>22Q</b>		2,2 x 2,2	9 pcs. 592 x 592 3 pcs. 592 x 287 3 pcs. 287 x 592 1 pcs. 287 x 287	49.000 m <sup>3</sup> /h
<b>25R</b>		2,5 x 2,2	12 pcs. 592 x 592 4 pcs. 592 x 287	56.000 m <sup>3</sup> /h
<b>25Q</b>		2,5 x 2,5	16 pcs. 592 x 592	64.000 m <sup>3</sup> /h
<b>28R</b>		2,8 x 2,5	16 pcs. 592 x 592 4 pcs. 287 x 592	72.000 m <sup>3</sup> /h



## Bag filter

Bag filter comprising tear-resistant polyester fibres. Filter extractable on slide rails up to size 20Q or filter wall that can be operated from the dust air side

Filter category: G4; depth: 360 mm  
 Filter category: M5 - F9; depth: 600 mm or 360 mm  
 Temperature-resistant: up to 80 °C  
 Humidity resistance: up to 100% relative humidity  
 Filter frame: galvanised steel sheet; long service life and large dust storage capacity (completely incinerable configuration on request). Biostatic configuration available on request



*Note:* Use in all AIRBOX series  
 Max. permitted filter output resistance values acc. to RLT 01:

- In quality category G4: 150 Pa
- In quality category M5, M6, F7: 200 Pa
- In quality category F8 and F9: 300 Pa

Dimensioning pressure loss: (Initial + final pressure drop)/2  
 All filter components are equipped with measuring ports incl. cap; inspection windows and lighting from size 13Q onwards.

A system of clamping rails is available up to size 20Q. This allows the filters to be arranged compactly, because there is no need for an operating space for the filters on the dust side. The clamping rail configured as a closed square profile along the entire width of the unit ensures an evenly firm mounting for the individual filter elements. The permanently installed hollow profile seal guarantees a high level of seal integrity even after many filter changes.

### Units in weatherproof design:

- First filter stage after the outside air entry
- Frame made from stainless steel 1.4301

### Units in hygiene design:

- Filter frame made from stainless steel 1.4301
- All filter modules with inspection window and lighting
- Filter change only permitted on the dusty air side
- The last filter stage is arranged on the pressure side after the fan at the end of the casing

### Units in explosion-proof design:

- Electrical conductive medium due to integrated metal mesh; electric charge build-up in the filters is thus avoided
- Can be used for gas explosion protection  
 Ex II 2 G/II A - II C and for zones 1 and 2 (DIN EN 1127-1)

Overview of the filter categories for bag filters

Filter category	Average efficiency at 0.4 µm	Dust storage capacity g (size 592 x 592)	Bag length
G4	-	760	360 mm
M5	54 %	550	600 mm
M6	77 %	495	600 mm
F7	87 %	400	600 mm
F8	93 %	324	600 mm
F9	97 %	110	600 mm

**Compact filter**

Compact filter comprising tear-resistant, synthetic polypropylene fibres  
 Filter category: M5 - F9  
 Filter frame: completely plastic, fully incinerable

*Note:* Use in all AIRBOX series except A20

The permitted max. final filter pressure loss as well as information for units in hygiene and weatherproof configuration are identical to those of the bag filters.



**Activated carbon filters**

Activated carbon filters of the Rosenberg A 2600 type consisting of two cylinders with different diameters, made from plastic. Both cylinders are connected together by a shared base plate to make a sturdy unit. The cavity between the cylinders has a layer thickness of 26 mm, is filled with activated carbon and compacted on a shaker table.

The activated carbon filter cartridges of the Rosenberg A 2600 type are mounted on a galvanised mounting frame. Each cartridge is provided with a seal which ensures a gas-tight seat between the cartridge and the base plate. The cartridge is locked by means of three special pins (bayonet lock).

**Application:**

Filter for absorbing gaseous and intensely odorous pollutants from the outside air and extract air. Use of cartridges up to max. 40 °C air transport temperature as well as a relative humidity of maximum 70%. Impregnated special activated carbon is used for gases such as nitrous gases, hydrogen sulphides, hydrogen chlorides, amines, ammonia (on request). Low-oxygen activated carbon is used for moist gases, because water vapour reduces the capacity of the activated carbon. The Rosenberg activated carbon is particularly hydrophobic due to the gas activation process, which makes it suitable for adsorption from moist gases as well.

*Note:* Use in all AIRBOX series

**Units in hygiene design:**

- Post-filter (min. F8) is required when used in the supply air
- Filter frame for pre-filter and base plate made from stainless steel 1.4301



The factors which are important for effective utilisation of the activated carbon are the velocity, layer thickness, particle size and contact time. Supply or exhaust air systems are specified with 0.1 – 0.5 s. The incident flow velocity is 0.05 to 0.5 m/s. The technical contact time results from the average velocity through the carbon layer. The sorption level of a carbon filter depends on the quality of the carbon. The activated carbon used is a „high activity“ carbon, i.e. it can absorb large amounts of odour molecules. A pre-filter (min. F7) is essential.

- Length of standard cartridge: 450 mm
- Special length: 600 mm (e.g. for highly polluted exhaust air from kitchens)

The air velocity in the unit depend on the use of activated carbon, and are generally between 1.0 and 2.0 m/s.

**Important!** Activated carbon is not allowed to become humid under any circumstances! Relative air humidity (up to max. 70%.

Sorption capability of Rosenberg A 2600 type activated carbon filters (Reference values at 70% relative air humidity and without a combination of impurities)	
Substance	Sorption capability
methyl mercaptan (CH <sub>2</sub> SH)	1,2 kg
hydrogen sulphide (H <sub>2</sub> S)	1,7 kg
Benzene (C <sub>6</sub> H <sub>6</sub> ) similar substances	8,0 kg

*The absorption capability can be increased by 10 – 20% if the filter is only loaded with 50% of its nominal capacity.*

## Z-line-Filters

Z-line filters are made from finely woven synthetic mats. All frame components are produced from high-quality solid cardboard, and have a wide-mesh support structure on the clean air side of the filter. The zigzag shaped folding of the mat in the Z-line filter means that a relatively large filter surface area is achieved in spite of the small installation depth. This provides a high separation efficiency and good dust storage capability with high flow rates.

Filter category G4; depth: 50 mm

*Note:* Use only in series A20



## Panel filters

Panel filters consist of an inherently rigid, folded, fibreglass-free and abrasion-resistant material. The filter absorb oils and greases, it is water repellent and prevents the build-up of bacteria (acc. to DIN EN 846). As a result, the panel filter prevents the growth of pathogens.

Filter category: M5-F9; depth: 96 mm

Filter frame: Completely plastic, fully incinerable

*Note:* Use in all AIRBOX series



## Metal filter weaved

The filter consists of a multi-layered aluminium flat wire mesh. On request, also available in stainless steel 1.4301. If the metal filter weaved are used as grease capture filters then a grease capture tray is fitted. On request, the filters are available in a split version (e.g. for cleaning in dishwashers, etc.).

Filter category: The pressure losses are approximately equivalent to a filter in quality category G4; depth: 25 mm / 48 mm

*Filter frame: Extractable and washable aluminium frame*

*Note:* Use in all AIRBOX series

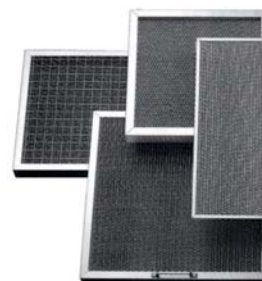

## HEPA filters

The filter consists of a high-quality fibreglass medium which retains its strength when wet, and is fitted with aluminium spacers with a special zigzag folding and edge protection. The filter is tested acc. to EN 1822. A test certificate is supplied on delivery. As a rule, pre-filtering is undertaken with M5 or F9 filters.

Filter category: H10 - H14 (acc. to Eurovent DIN EN 779)

Efficiency: DOP 99.99 % (H13)

Decontamination factor:  $10,000 < D_f < 100,000$

Filter frame: Humidity-resistant plywood frame with two-component compound and neoprene seal; the frame material is also available made from extruded aluminium profiles or galvanised steel sheet with (or without) painting.

*Note:* Use in all AIRBOX series





bag filter with clamping rails



HEPA filters



Panel filter (clean air side)



Panel filter (dusty air side)



Standard filter frame with Compact filter

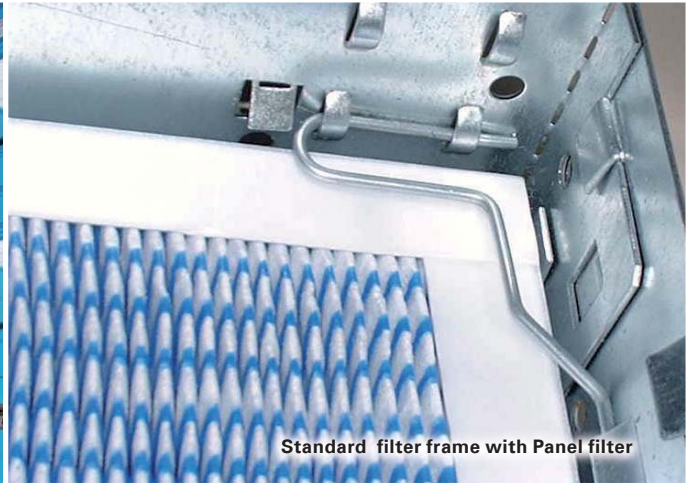

Standard filter frame with Panel filter

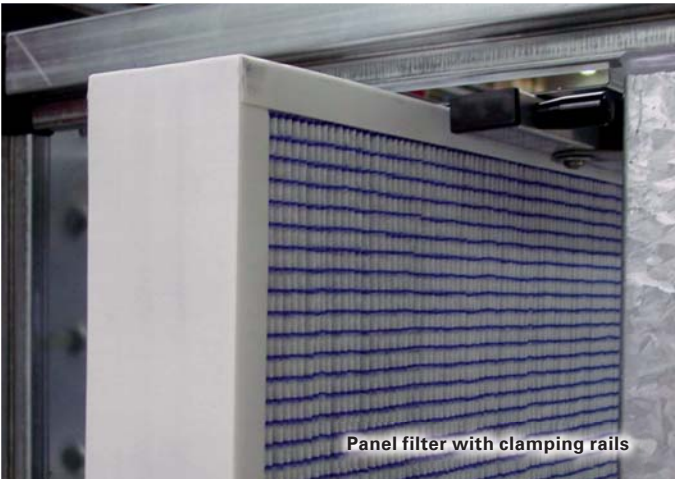

Panel filter with clamping rails



Metal filter weaved



## Humidifiers

In addition to temperature, adequate air humidity is important for a comfortable room climate. The humidifier types which can be used include not only spray and evaporative humidifiers but also steam or high-pressure humidifiers.

The spray humidifiers distribute water over a large surface area in the air flow with the help of fine nozzles. The water that is not absorbed by the air is collected in a drain tray and carried away, or sprayed back into the air flow in the case of recirculating spray humidifiers. Humidification in the spray chamber takes place adiabatically. The air cools at the same time as absorbing humidity. The spray chambers also serve as air scrubbers by removing odours and pollutants from the air. High pressure humidifiers, as a special type of spray humidifiers, operate with high water pressure, resulting in very finely atomized water.

Evaporative humidifiers comprise a honeycomb structure, mostly in the form of a cartridge, through which air flows. If required, water is distributed evenly over the structure from a reservoir trough which holds the water. The air which flows through picks up the humidity and cool down as it does so. In order to guarantee long-lasting and hygienic operation of the system, it is sensible to have an automatic salt removal function to prevent scaling, as well as a dosing unit to prevent bacteria formation.

Steam humidifiers operate with dry steam that is injected into the air flow via steam lances. The air temperature remains

constant with this type of humidification. The advantages of this humidifier type are the mechanical simplicity within the unit and its good hygienic properties.

Exclusively corrosion-resistant materials such as aluminium and stainless steel are used as materials for the humidifiers. Condensation trays are always provided in the base area in humidifier empty chambers



Spray humidifiers

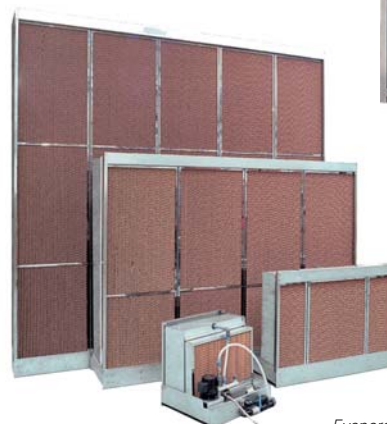

Evaporative humidifiers



## Silencers

Silencing is always required where the noise from the fan and the flow noises of the air conditioning unit cannot be tolerated. Acoustic insulation traps are used in the unit or the network of ducts. The design of the acoustic insulation traps means they absorb part of the airborne noise. Sound reduction can be varied by using different lengths and shapes of traps.

The integrated silencers available for modular Rosenberg air handling units are made up of several acoustic insulation traps adjacent to one another, which are positioned in the unit by means of a spacer and slide rails. The acoustic insulation traps can be removed from the unit for inspection and cleaning after the unit panels has been removed on the operating side



The components of the individual acoustic insulation traps are:

### *Mineral wool absorption material:*

- Non-flammable DIN 4102 category A II
- High biosolubility
- Silicone-free
- Impregnated for humidity repellence
- Protected against rotting
- Max. operating temperature 100 °C

### *Covering of the mineral wool made from glass silk:*

- Abrasion resistant up to an air speed of 25 m/s
- Easy to clean

### *Frame made from galvanised steel sheet*

For applications in the explosion-proof area, the acoustic insulation traps are additionally provided with a perforated sheet cover.





## Multi blade dampers

In our unit series, we use high quality dampers from well-known German manufacturers in order to provide a barrier on the air side when the system is stopped.

In weatherproof units, we always install dampers within the unit casing so that all parts, including the drive, are protected against the elements as well as possible. In units for indoor installation, the dampers can be fitted both inside the unit casing and outside on the unit casing. When there are increased hygiene requirements and indoor installation, it is highly recommended for the dampers to be mounted on the outside of the unit, because this means the damper drive will not be in the air flow and thus difficult-to-clean nooks and crannies are avoided.

If necessary, we can also supply dampers in special versions such as:

- Frame and blades in stainless steel V2A (1.4301)
- Frame and blades in aluminium
- Powder-coated frame in any RAL colour

The table on the following page provides an overview of the most important properties of the multi-blade dampers used by Rosenberg:



Decoupled duct connection in hygiene configuration acc. to DIN 1946 T4:

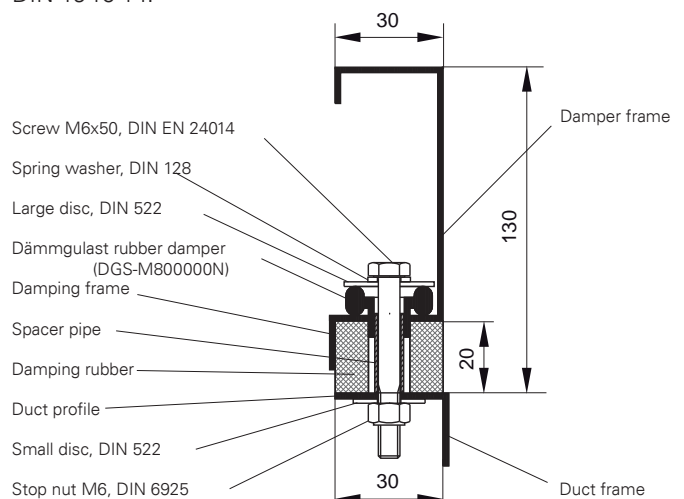

damper design	airbox size	overall length 120 mm	overall length 180 mm	lamella galvanizes	lamella aluminium (EN AW-6060 T66)	frame galvanized	frame aluminium (EN AW-6060 T66)	cog wheel inside (PA 6.6 GF30)	cog wheel outside (PA 6.6 GF30)	connecting rod galvanized	frame 20 mm	frame 30 mm	decoupled duct connection EPDM 30x20
airtight EN 1751, class 2 indoor units	07F - 10F	X			X	X		X			X		
	≤ 13Q	X			X	X			X			X	
	≥ 16R		X		X	X			X			X	
airtight EN 1751, class 2 weatherproof units	07F - 10F	X			X	X		X			X		
	≤ 13Q	X			X	X			X			X	
	≥ 16R		X		X	X			X			X	
airtight EN 1751, class 4	07F - 10F	X			X	X			X		X		
	≤ 13Q	X			X	X			X			X	
	≥ 16R		X		X	X			X			X	
airtight EN 1751, class 4, hygienic according DIN 1946 T4	07F - 10F	130*			X		X		X			X	X
	≤ 13Q	130*			X		X		X			X	X
	≥ 16R		175*		X		X		X			X	X
airtight EN 1751, class 2 exproofed design according ATEX (Ex II 2/2 GD IIC TX)	all		X	X		X				X		X	

\*total length including the seal

## Damper actuators

We exclusively use high-quality damper actuators from Belimo for driving the multi-blade dampers, and we use actuators from Schischek for explosion-proof units. The size and configuration of the damper actuators depends on the torque of the damper to be driven, as well as the required function appropriate for the unit control. The torque of the damper depends both on the size and its configuration. As a rule, a damper with a higher sealing category requires a higher torque

Possible versions of a damper actuator:

- Torque 4 Nm to 40 Nm
- Voltage: 230 V AC or 24 V AC/DC
- Continuous function, open/closed, open/closed/hold
- With or without return spring for automatic closing of the damper on power failure



## Connectors

The most straightforward and most frequently used variant is the flexible connector. It comprises 2 frames made from galvanised steel sheet with fabric tape made of PVC-coated polyester in between

- Installation length 130 mm (extended length 140 mm)
- Frame dimensions: For flat units 07F to 10F: 20 mm all other sizes with 30 mm frame
- Operating temperature -30 °C to +70 °C

On request, special versions are available with:

- Special frame version in: Galvanised and coated steel or stainless steel V2A
- Special tape material (extended length and installation length may be different): Electrically conductive for explosion-proof applications, neoprene, operating temperature -20 °C to +120 °C, silicone, operating temperature -36 °C to +260 °C, glass silk with PU coating, or operating temperature -36 °C to +150 °C

The compensating connectors chiefly corresponds to the previously described damper in hygiene configuration acc. to DIN 1946 T4, but without damper blades and gear assembly.

The operating temperature of the compensating connectors is limited by the EPDM seal described previously, as well as the elements of the decoupled screw connection, and is therefore in the range from -20 °C to +80 °C.



Pict.: Flexible connector



Pict.: Compensating connector





## Transport and installation options









Our many years of experience mean that we can offer you the service of having the systems installed and commissioned by our qualified specialists. For this purpose, we require specific information from you and/or preliminary work before the start of installation and operation:

- Provision of construction plans for the building in question, as well as the corresponding and necessary electric wiring diagrams
- Information about the particular conditions on site which might significantly influence the course of installation
- Information about the installation date, installation options and transport routes on-site
- Access entitlement for our personnel and provision of keys to the rooms in question
- Permission to park at the buildings in question during the period of the installation work

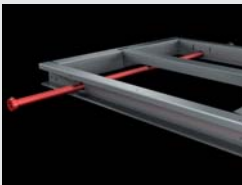
Transport and installation of the air handling units depend on the size, weight and, last but not least, the installation location.

We can assist you with planning and implementation of all installation options, whether on a roof, façade or inside a building. All of our Airbox air handling units are equipped with a base frame for straightforward transport and installation. The table on the right-hand side provides an overview of the possible tools.



Description	Picture	Airbox Type	max. Module weight	max. size
lifting eyes for base frame		F40 / S40 / S60 / T60	1.100 kg	all sizes
lifting eyes base frame (welded)		S40 / S60 / T60	5.000 kg	all sizes
Transport pipe for base frame made of sheet steel		A20 / F40 S40 / S60 / T60	1.750 kg	all sizes
lifting eyes at the casing frame		S40 / S60	1.600 kg	all sizes
lifting eyes at the casing frame		A20	1.000 kg	all sizes
Module corner element		S40 / S60	1.100 kg	all sizes
Module corner element (with threaded rod)		S40 / S60	2.500 kg	all sizes ( flat units )
Module corner element for flat units		S40	1.000 kg	all sizes ( flat units )
Suspension eye for flat units		F40	250 kg	all sizes ( flat units )

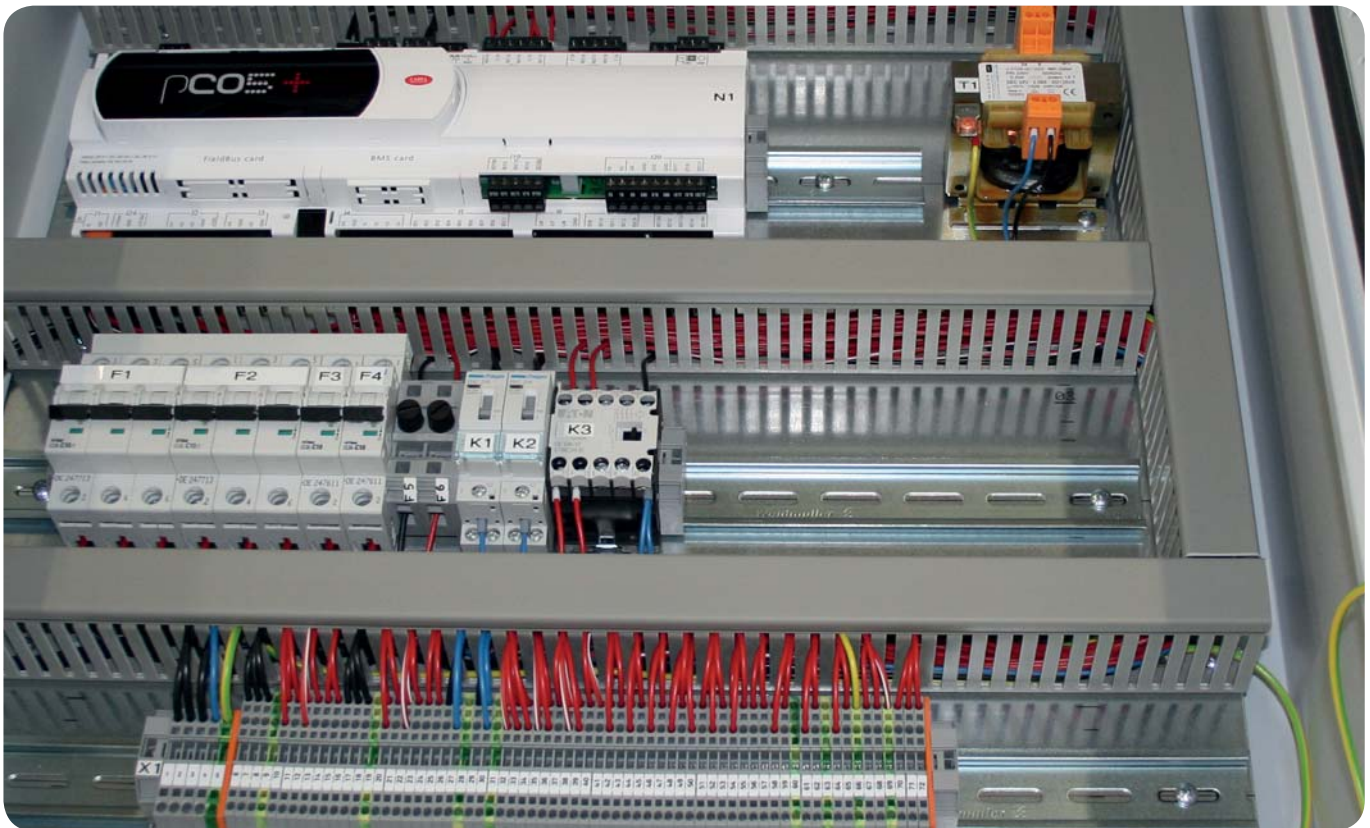

### Control units for Airbox air handling units

The control units adapted to Airbox units offer you optimum levels of convenience and safety in operation, monitoring and service of the system. The control units are produced according to VDE regulations, and meet the requirements of the applicable EC directives.

In this way, air handling units from Rosenberg represent an optimum unit together with the tailor-made control units. This concept achieves the objective of maximum system convenience and the highest levels of comfort with minimised energy use, cost-effectively and safely.

The Rosenberg controller series are suitable for supply air, room air or exhaust air temperature control. The control units are used for transformational control of directly driven fans, as well as for controlling standard motors, frequency inverters and EC motors. Exclusively microprocessor-based controllers are used for implementing the various open and closed-loop control functions in air ventilation systems, in order to permit a high level of control accuracy to be reliably achieved.

The compact controller series **MSD...TR (for standard motors)** or **RTE/D...TR (for external rotor motors)** are particularly suitable for room temperature / supply air temperature control in ventilation systems, and satisfies the most important basic functions of control technology. A controller with adjustable parameters is used for temperature control, with a memory that stores nine different, selectable ventilation system schematics.

In conjunction with a room sensor and supply air sensor in the duct system, the room or supply air temperature is set by the control PCB contained in the compact controller series. The TR control unit has an operating panel in the control cabinet door with a user-friendly two-line plain text display. Adaptations to the control profile can be undertaken on this operating panel. A week programme is also integrated for switching the system on and off, or setting various temperature setpoints with three switching times per day.

Each TR control unit has a motor protection feature which guarantees optimum motor protection in motors with a thermocontact or PTC resistor. If the maximum permitted winding temperature is exceeded then the motor is disconnected from the mains.



The latest DDC technology is used in **control units in the Airtronic series**. The Airtronic control unit enables not only standard motors and external rotor motors to be controlled, but also frequency inverter operation as well as control of energy-saving EC fans. The advantages of this technology also include the option of customer-specific adaptation for many applications, as a result of which the Airtronic is suitable for a highly diverse range of control functions. The Airtronic is available in two versions – **Airtronic Basic** and the more elaborate **Airtronic D** – which differ according to the maximum number of inputs and outputs, and are individually programmed for each air ventilation system.

Functions such as pressure control, flow rate control or fan control according to air quality or CO<sub>2</sub> are also possible here. On request, the Airtronic control units can be connected to a higher-level building management system via the LON bus, BACnet or the MODBus.

The operating panel can be installed directly in the control cabinet or, alternatively, be supplied as a remote operating panel. A week programme is also integrated for switching the system on and off, or for setting different nominal temperatures and ventilation specifications with seven switching times per day. Fault messages, system statuses and internal settings are displayed in plain text.

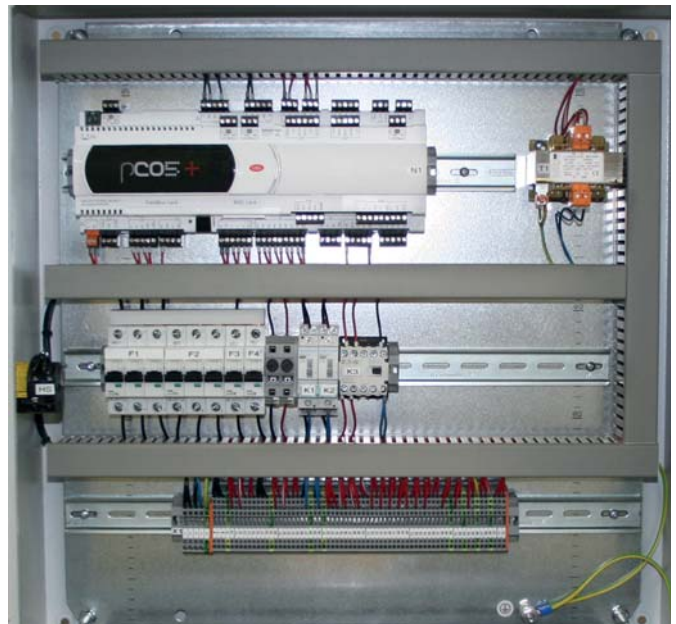

Sample illustration of an AIRTRONIC Basic control unit

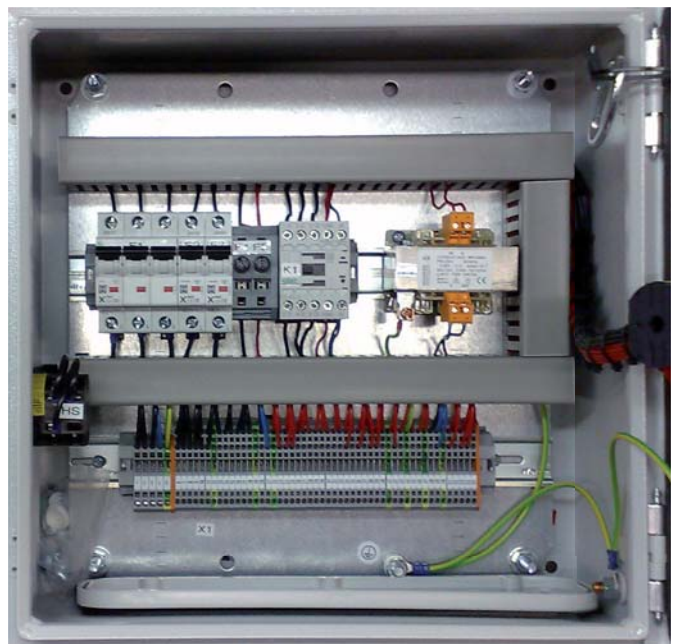

Sample illustration of an MSD-TR control unit



Sample illustration of the operating panel integrated in the control cabinet



Sample illustration of the external operating panel



Both controller series, Airtronic and TR, have a master switch. This makes it possible to isolate the entire ventilation system.

## Comparison between control unit types:

	Controller variant	MSD TR <sup>*)</sup>	RTE/D TR <sup>*)</sup>	Airtronic Basic <sup>*)</sup>	Airtronic D <sup>*)</sup>
<b>Control cabinet</b>	type of protection	IP54	IP54	IP54	IP54
<b>Fan drive</b>	external rotor motor 5-step	-	X	-	X
	external rotor motor 3-step	-	-	X	X
	IEC standard motor 3-step	X	-	X	X
	IEC standard motor 2-step	X	-	X	X
	IEC standard motor 1-step	X	-	X	X
	IEC standard motor stepless (FU)	-	-	X	X
	pole changing Dahlander winding	X	-	X	X
	gentle start-up (IEC standard motor 1-step)	X	-	X	X
<b>Current</b>	Maximum achievable motor current	8 A	15 A	43 A	43 A
<b>Fire protection</b>	Fire alarm input	X	X	X	X
<b>Monitoring</b>	Air flow	X	X	X	X
	Filter exhaust air	X	X	X	X
	airstream supply	X	X	X	X
	airstream exhaust	X	X	X	X
	Icing HRU sequence	X	X	X	X
<b>Memory</b>	Alarm memory for protection functions	-	-	10 messages	10 messages
		-	-	X	X
<b>Message</b>	Fault message	-	-	Potential-free collector contact	Potential-free collector contact
<b>Damper control</b>	Bypass damper	X	X	X	X
	Outside air damper	X	X	X	X
	exhaust air damper	X	X	X	X
	recirculationair damper	hand / automatic	hand / automatic	hand / automatic	hand / automatic
	Soft start-up	-	-	X	X
<b>Heating sequence</b>	Hot water heating coil	X	X	X	X
	Electric heating coil (bis 40 kW)	up to 4-step	up to 4-step	up to 4-step	up to 6-step
<b>Cooling sequence</b>	Water/air cooler	X	X	X	X
	Chiller	X	X	X	X
<b>Heat recovery sequence</b>	Plate heat exchangers	X	X	X	X
	Glycol circuit (CCS)	-	-	-	X
	Rotary heat exchangers	X	X	X	X
<b>Ventilation control</b>	Constant volume flow control	-	-	-	X
	Constant pressure control	-	-	-	X
<b>Temperature control</b>	Supply air temperature control	X	X	X	X
	Maximum limitation on supply air temperature	X	X	X	X
	Minimal limitation on supply air temperature	X	X	X	X
	Room air temperature control	X	X	X	X
	exhaust temperature control	X	X	X	X
	room - (exhaust-) (supply air cascade controller)	X	X	X	X
	Summer / winter compensation	-	-	X	X
<b>Humidification</b>	Humidifier enable	-	-	-	X
<b>Ventilation functions</b>	Stabilize mode heating	X	X	X	X
	Stabilize mode cooling	X	X	X	X
	Night-time ventilation function	X	X	X	X
	Exhaust air fan separately switchable	X	X	X	X
<b>Operation / display</b>	Unit master switch	X	X	X	X
	Control cabinet panel	X	X	X	X
	Remote operating panel possible	X	X	X	X
	- Tableau LCD	-	-	X	X
	- Tableau mechanic/analog (Poti,Lamps)	X	X	-	-
	Timer switch	X	X	X	X
	- On/Off	week program	week program	week program	week program
- Variable controller parameters	-	-	6 times per day	6 times per day	
<b>Network</b>	LON	-	-	X	X
	MODBus	-	-	X	X
	BACnet	-	-	X	X

\*) the collection of functions have to be according to the unit  
not all combinations are parallel available